

# HCoC

*The Hague Code of Conduct against  
the Proliferation of Ballistic Missiles*

## NORTH KOREAN SHORT RANGE SYSTEMS

### *Military consequences of the development of the KN-23, KN-24 and KN-25*

Stéphane Delory, Senior Research Fellow, FRS

Antoine Bondaz, Research Fellow, FRS

Christian Maire, Associate Researcher, FRS

GEO4i

2022 | In-depth report

North Korea's recent flurry of missile tests, in particular of short-range missiles, has put the spotlight on its efforts to develop new capabilities in this range and to replace Soviet-inherited weapons with modern and accurate systems. Especially, the development of the KN-23, the KN-24 and the KN-25 is bound to be significant in Pyongyang's capacities and strategy. This study focuses on the new systems introduced, and assesses their potential impact as conventional weapons and as non-conventional weapons. Through an analysis of the possible capacities of these systems, this study examines their consequences on North Korean strategy. It concludes by exploring what this change of strategy may lead to, in military terms, and in political terms, on the Korean peninsula.

## AKNOWLEDGEMENTS

The authors would like to thank very sincerely Vann van Diepen and Emmanuelle Maitre for their highly valuable contribution to this study and patient proof-reading, as well as Lauriane Héau and Marie Raymond for the editing process.

Cadenza Academic Translation realised the translation of this report.

## DISCLAIMER

This document has been produced with the financial assistance of the European Union. The contents of this document are the sole responsibility of the Fondation pour la Recherche Stratégique and can under no circumstances be regarded as reflecting the position of the European Union.

## About the authors

**Mr Stéphane Delory** is a Senior Research Fellow at the Fondation pour la Recherche Stratégique (FRS). His expertise covers in particular delivery vehicles, missile defence, and new technologies. Mr Stéphane Delory has written extensively on missile-related technologies, development in the field of hypersonic, space launchers as well as on export control regimes, and arms control arrangements linked to means of delivery. As such, he contributes regularly to the FRS-led EU-funded project on the Hague Code of Conduct against the Proliferation of Ballistic Missiles.

**Dr Antoine Bondaz** is a Research Fellow at the Fondation pour la Recherche Stratégique (FRS), the Director of the FRS-KF Korea Program as well as the Taiwan Program on security and diplomacy, and an Associate Professor at Sciences Po Paris. His research focuses on China, Taiwan and Korea's foreign and security policy, and strategic issues in East Asia. He advises senior government officials in France and Europe, and participates in numerous high-level track 1.5 dialogues with top Asian government officials. He has testified before the French National Assembly and Senate, the European Parliament, the OECD, NATO and at the UN. He holds a Ph.D. in political science from Sciences Po.

**Mr Christian Maire** is an Associate Research Fellow at the FRS where his research focuses on space, missile technologies, and missile defence. His recent work includes a study on Russian hypersonic missiles, small launchers and anti-satellite weapons. Previously, he worked in the aerospace industry and especially with ArianeGroup. Mr Christian Maire holds an engineering degree from the ESTACA.

**GEO4i** is a French company specialised in geospatial data management, valorisation of geospatial information and imagery analysis in the fields of defence, security, safety and competitive Intelligence. The expertise of Geo4i embraces different fields like imagery intelligence, geospatial intelligence, geospatial data management, data mining and open data.

# Table of Contents

TABLE OF CONTENTS .....	3
TABLE OF FIGURES.....	6
ABBREVIATIONS.....	9
<b>1 THE DEVELOPMENT OF THE NORTH KOREAN STRIKE SYSTEM .....</b>	<b>10</b>
1.1 General overview of the North Korean ballistic missile arsenal .....	10
1.2 Elements of nuclear doctrine .....	13
1.3 Conventional options for reorienting the arsenal.....	15
<b>2 NORTH KOREA'S SHORT RANGE ARSENAL .....</b>	<b>17</b>
2.1 Size of the arsenal .....	18
2.2 Missile accuracy .....	20
2.2.1 Range and accuracy .....	20
2.2.2 Use over shorter ranges.....	22
2.3 Conventional payload types and possible effects .....	24
2.3.1 Effects of unitary munitions.....	25
2.3.2 Effects of submunitions.....	28
2.4 Chemical strikes on military targets.....	30
2.5 Adapting the strike system to the threat from the United States and South Korea .....	35
2.5.1 The modernisation of the deep strike capability of the United States and South Korea .....	35
2.5.2 Impact of the development of missile defences on the technical choices of North Korea .....	37
<b>3 THE TRANSFORMATION OF THE ARSENAL .....</b>	<b>42</b>
3.1 The development of solid propellant production capability .....	42
3.2 The choice of quasi-ballistic systems, and questions raised by the KN-23 and KN-24 tests .....	47
<b>4 THE NEWLY DEVELOPED SYSTEMS: KN-23, KN-24 AND KN-25 .....</b>	<b>53</b>
4.1 The KN-23 and KN-23A .....	53
4.1.1 The KN-23 .....	53
4.1.2 KN-23A.....	64
4.2 KN-24 .....	65
4.3 KN-25 .....	70
4.3.1 The KN-09 as the probable basis for the acquisition of technological know-how..	71
4.3.2 Specific features of the KN-25 .....	73

4.4	<b>Assessment of missile accuracy</b> .....	76
<b>5</b>	<b>POTENTIAL OPERATIONAL USES</b> .....	<b>81</b>
5.1	<b>Maintaining a strategy based on the use of non-conventional munitions</b> .....	<b>81</b>
5.1.1	The contribution of new weapons systems .....	81
5.1.2	The role of missile modernisation in the context of chemical agent use.....	83
5.2	<b>Conventional strike options as part of a coercive strategy</b> .....	<b>85</b>
5.2.1	Economic coercive strikes.....	87
5.2.2	Strikes against centres of power or major administrative infrastructure.....	90
5.2.3	Strikes on military targets for political coercive purposes .....	91
5.2.4	Tactical strikes against South Korean artillery positions .....	92
5.2.5	Strikes against missile defence units and architecture .....	94
5.3	<b>The importance of defences in a coercive strike scenario</b> .....	<b>97</b>
5.4	<b>Aspects to consider in a high-intensity conflict scenario</b> .....	<b>99</b>
<b>6</b>	<b>CONCLUSION</b> .....	<b>102</b>
6.1	<b>North Korea’s short-range capabilities transform the balance of power on the peninsula</b> .....	<b>103</b>
6.2	<b>The need to strengthen frameworks for analysing ballistic missile risk and proliferation</b> .....	<b>104</b>
6.2.1	Long-range and short-range .....	104
6.2.2	Quantitative and qualitative analysis .....	104
6.2.3	Military and political dimensions .....	104
6.2.4	Direct and indirect impact.....	105
6.2.5	Tangible and intangible technology transfer .....	105
6.2.6	A credible European commitment to ballistic missile non-proliferation.....	106

## Table of Figures

<b>Figure 1.</b> Russian SS-1c and North Korean current short-range ballistic strike systems .....	18
<b>Figure 2.</b> Potential CEP of the Scud B as a function of range/CEP ratio .....	21
<b>Figure 3.</b> Theoretical area of effect of a missile as a function of Lethal Radius and CEP .....	24
<b>Figure 4.</b> Probability of effect with 2 (P2) and 3 (P3) missiles with a Lethal Radius of 50 and 100 metres .....	25
<b>Figure 5.</b> Effect of detonating a 985 kg Scud B missile warhead with 545 kg of explosive at 15 m altitude from a given distance .....	26
<b>Figure 6.</b> Probability of destruction of a target vulnerable to 25 psi of overpressure for 985 kg warheads (545 kg of explosive) used in salvo .....	27
<b>Figure 7.</b> Possible 600 m CEP for short-range use of a Scud B (red circle) and 200 m CEP for a KN-02 (yellow circle) relative to the area of the Joongbu LNG Plant (Seoul) .....	28
<b>Figure 8.</b> Probability of the target falling within the area of effect as a function of LR and CEP .....	29
<b>Figure 9.</b> Probability of neutralizing an air base with two 50 x 150 m runways using 10 kg runway submunitions .....	30
<b>Figure 10.</b> Probability of intercepting a salvo attack based on the number of interceptors and the number of ballistic missiles .....	39
<b>Figure 11.</b> Possible production zone for propellant for the KN-02, reconstruction (October 2012) and current state of the infrastructure, possibly for the KN-23 and KN-24, north zone .....	43
<b>Figure 12.</b> Foundations of the production zone, October 2012, and completion of the building, December 2014, south zone .....	43
<b>Figure 13.</b> Test of a variant of the KN-02, August 14, 2014. ....	45
<b>Figure 14.</b> Composite material structure on the propulsive section of the Pukguksong-2.....	45
<b>Figure 15.</b> KN-23 (data from the Panel of Experts) and SS-26E (data from open sources) .....	54
<b>Figure 16.</b> Relation between the diameter of the wheel of the MZTK 7930 launcher and the 9M720 SS-26E missile .....	55
<b>Figure 17.</b> Relation between the diameter of the wheel of the MZTK 7930 type launcher and the KN-23 missile .....	55
<b>Figure 18.</b> Estimation of the possible dimensions of the KN-23.....	56
<b>Figure 19.</b> KN-24 Propellant mass vs diameter .....	56
<b>Figure 20.</b> Data comparison between SS-26 and estimates for KN-23.....	57

<b>Figure 21.</b> Volume and mass of the military payload of the SS-1c/Scud B, the SS-26 E or M, and estimation of the maximum mass of that of the KN-23 and KN23A .....	57
<b>Figure 22.</b> Activation of movable control surfaces at launch, and presence of jet deflectors on the KN-23 .....	58
<b>Figure 23.</b> Angle of attack in the terminal phase of flight for the KN-24.....	59
<b>Figure 24.</b> Re-entry and effect of shallower angle of penetration (red circle) of an Iranian missile and orientation of the blast upon impact .....	59
<b>Figure 25.</b> Trajectory of KN-23 with pull-up, test on 25 July 2019 (left) and (right) estimate of the first part of the trajectory (350km?) .....	60
<b>Figure 26.</b> Area covered by a 350km missile fired from the Sakkamol and Kal-gol bases (North Korea) .....	61
<b>Figure 27.</b> Photograph of firing by KCNA and zone of firing as identified by a member state (40°01'47"N, 125°13'38"E) .....	63
<b>Figure 28.</b> Probably operational version of tracked TEL for the KN-23 .....	63
<b>Figure 29.</b> Launch of the KN-23 from a train.....	63
<b>Figure 30.</b> Possible dimensions of the KN-23A .....	64
<b>Figure 31.</b> KN-23 and KN-23A upper sections.....	64
<b>Figure 32.</b> KN-24 (Panel of Experts data) and MGM-140 (data from open sources) .....	65
<b>Figure 33.</b> Relation between the width of the TEL and the diameter of the KN-24 .....	66
<b>Figure 34.</b> Dimensions of the TEL and diameter of the missile .....	66
<b>Figure 35.</b> Visual comparison between the MGM-140 (top) and the KN-24.....	67
<b>Figure 36.</b> Possible dimensions of the KN-24 missile .....	67
<b>Figure 37.</b> Possible configuration of the warhead of the KN-24 .....	68
<b>Figure 38.</b> Comparison with KN-24 payload section.....	68
<b>Figure 39.</b> KN-25 (Panel of Experts data).....	71
<b>Figure 40.</b> Precision strike by KN-09, photograph published in 2016 .....	73
<b>Figure 41.</b> Opposing retractable control surfaces (back of the rocket) and attitude control surfaces (front of the rocket) .....	74
<b>Figure 42.</b> Explosion during the test of a KN-24, silhouette of the islet of Al-som on the control screen used by Kim Jong Un .....	77

<b>Figure 43.</b> Possible axes of firing from the firing site of Yonghung (KN-25?), from the Kwail air base (KN-23) and from the firing range of Hungnam (KN-24) in relation to zones of detonation attributed to each missile on the islet of Al-som.....	78
<b>Figure 44.</b> Images probably showing the launch of a KN-25 on 1 August 2019.....	79
<b>Figure 45.</b> Images of the launch of a KN-23 on 6 August 2019.....	79
<b>Figure 46.</b> Images of the launch of a KN-24 on 9 August 2019.....	79
<b>Figure 47.</b> Coherence map – Sentinel-1 analysis.....	80
<b>Figure 48.</b> Theoretical coverage area of 500 kg of VX under optimal conditions at Osan Air Base, north-east dispersion axis.....	84
<b>Figure 49.</b> Hypothetical representation of strikes on the Giheung semiconductor production site by a weapon with a CEP of 30 m (yellow circle) or 60 m (red circle), representative of the possible accuracy of the KN-23 and KN-24 missiles.....	88
<b>Figure 50.</b> Vulnerabilities on the incoming power grid of the Paju P10 plant for a weapon with a CEP of around 30 m – Electric Switch Yard, Kyonggi Area, 37°48'21"N, 126°46'05"E.....	89
<b>Figure 51.</b> Power plants (yellow circles) and substations (blue circles) that distribute electricity to the Seoul, Daejeon, and Pyeongtaek region.....	90
<b>Figure 52.</b> Example of a high-capacity hardened position – North Kyonggi Area – 37°49'43"N, 126°44'58"E.....	93
<b>Figure 53.</b> MIM-140 Patriot PAC-3 ADS/ABM battery at Osan Air Base, 37°04'36"N, 127°16'06"E.....	95
<b>Figure 54.</b> Deployment of the Jincheong-Gun region Green Pine ABM radar, Jincheon-gun, 36°50'29"N, 127°24'23"E.....	95
<b>Figure 55.</b> THAAD deployment from the Seongju area, Lotte Skyhill Seongju Country Club Facility, 36°02'44"N, 128°13'24"E.....	96
<b>Figure 56.</b> South Korea's KC-330 and E-7 on the tarmac at Gimhae.....	97



## Abbreviations

**C2:** Command and Control

**C4ISR:** Command, Control, Communications, Computers, Intelligence, Surveillance, and Reconnaissance

**CEP:** Circular Error Probable

**DMZ:** Demilitarised Zone

**DRPK:** Democratic People's Republic of Korea

**FAE:** Fuel-Air Explosive

**GNSS:** Global Navigation Satellite System

**HCoC:** Hague Code of Conduct against the Proliferation of Ballistic Missiles

**ICBM:** Intercontinental Ballistic Missile

**ISR:** Intelligence, Surveillance, and Reconnaissance

**LR:** Lethal Radius

**MaRV:** Manoeuvrable Re-entry Vehicle

**MRBM:** Medium-range Ballistic Missile

**SRBM:** Short-range Ballistic Missile

**TEL:** Transporter Erector Launcher

**WMD:** Weapon of Mass Destruction

## 1 The development of the North Korean strike system

---

The study of North Korea's short-range strike capability raises a number of issues. As a result of the asymmetry between North Korea's conventional forces and those of South Korea and the United States, North Korea has built its national defence strategy around weapons of mass destruction (WMD), firstly chemical (and possibly biological),<sup>1</sup> and then nuclear. As such, the country has constructed its military capability primarily in line with a logic of *threatened use* rather than actual use, for North Korean forces would undoubtedly be incapable of sustaining an exclusively conventional conflict. Furthermore, the use of WMD against South Korea or one of its allies – most obviously the United States but also, from the North Korean perspective, Japan – can only be regarded as a last resort, since it could lead to massive conventional but also potentially nuclear retaliation. The constraints on any actual use of North Korea's military capabilities, especially those involving WMD, are such that it has long been assumed that North Korea sees its nuclear programme as a negotiating tool. The resumption of missile tests and the modernisation of its arsenal seem to counter this hypothesis, but the prevailing view remains that the main function of the country's nuclear weapons is to legitimate and protect the regime, and that the logic of deterrence takes precedence over that of coercion.<sup>2</sup>

### 1.1 General overview of the North Korean ballistic missile arsenal

Until recent years North Korea's existing capabilities made any military approach other than the one described above nearly unfeasible, since its delivery systems were too inaccurate to be used for selective strikes. This limited North Korea's ability to use them or even to threaten to use them for specific political objectives. The capabilities they did have were nonetheless powerful and numerous enough to prevent unilateral military operations by South Korea or the United States and even to support *ad hoc* coercive actions. This strategic model has proven to be effective: the deterrent effect of North Korea's arsenal has allowed it not only to ensure the survival of the regime but also to confront the international community directly by developing its WMD programmes, and even to engage in limited military aggression, without exposing itself to anything other than a diplomatic response. At first glance, there seemed, therefore, to be no imperative need to change the current deterrence model, and North Korea could well have kept it as it were, with minor adjustments. However, the repetition of nuclear tests, the technological choices made for second-generation delivery systems and the doctrinal elements presented by North Korean officials seem to herald a profound transformation of the country's deterrence strategy.

In their attempts to evaluate the role of North Korea's arsenal and nuclear weapons should deterrence fail, some authors have suggested that the principal aim of its strategy might be to involve other actors in the conflict, in particular China (a catalytic posture).<sup>3</sup> Since 2017, however, other analysts have raised

---

<sup>1</sup> The subject of biological weapons will not be addressed in this report, as information on stockpiles is even more patchy than in the case of chemical agents, and the possible *modus operandi* of operations is particularly difficult to assess.

<sup>2</sup> Jonathan D. Pollack, 'North Korea's Nuclear and Missile Programs: Strategies, Directions, and Prospects,' Brookings Institution, January 2018), [https://www.brookings.edu/wp-content/uploads/2018/02/fp\\_20180202\\_north\\_koreas\\_nuclear\\_missile\\_program.pdf](https://www.brookings.edu/wp-content/uploads/2018/02/fp_20180202_north_koreas_nuclear_missile_program.pdf).

<sup>3</sup> Vipin Narang, 'Nuclear Strategies of Emerging Nuclear Powers: North Korea and Iran,' *The Washington Quarterly*, Spring 2015, <https://s3.amazonaws.com/arena-attachments/891371/b8ad2feaf48cb3dbee2e67bdfc0f7dc1.pdf?1487619152>.

the possibility of more operational postures, with the likely adoption of warfighting logics.<sup>4</sup> They argue that the deterrence strategy is based more on the capacity to carry out a strike that generates a military effect than on the sole threat of use or of indiscriminate retaliation. However, the majority of analyses take a relatively binary approach, discussing the evolution of the arsenal's capabilities with a focus on nuclear weapons, and paying little attention to other potential munitions (chemical weapons, but also conventional munitions), despite the fact that these may represent significant warfighting and crisis management tools for North Korea.

The main forms of modernisation observed in North Korea over the past decade or so clearly reflect a structured strategy designed to develop the country's strike capability in line with Pyongyang's political objectives, but also with what seem to be precisely determined military objectives. The effectiveness of North Korea's current deterrence model may suggest that the modernisation of its forces, and in particular its ballistic missile forces, aims primarily at strengthening its current deterrent model rather than to broaden its military options, including through a more systematic use of conventional strikes. This might lead to the assumption that North Korea intends to continue with a model in which the ability to deliver WMDs is the most important factor in its deterrence capability and remains the guarantor of the country's security. Such a strategy equates to existential deterrence, or, if it is assumed that delivery system modernisation will increase the resilience of the North Korean arsenal, to deterrence by punishment. Indeed, some commentators have emphasised that while the development of short-range missiles that has recently been observed presents a gain in capability, it does not alter the balance of power between North Korea and its declared adversaries. This framework of analysis suggests that there is unlikely to be any fundamental change to North Korea's deterrence model.<sup>5</sup> Others have presented the opposing argument that North Korea is developing a new deterrence model complementary to its existing one, through developing the assets required for either a conventional precision strike or a limited nuclear strike.<sup>6</sup> This transformation implicitly suggests the adoption of a graduated retaliatory strategy and the management of military operations, in both conventional and non-conventional terms.

In this context, the chosen options remain highly dependent on the existence of an effective strategic deterrence capability that minimises the risk of a massive response from the enemy and allows for

---

<sup>4</sup> Choi Kang and Kim Gibum, 'A Thought on North Korea's Nuclear Doctrine,' *The Korean Journal of Defense Analysis* 29:4 (December 2017); Bruce W. Bennett et al., *Countering the Risks of North Korean Nuclear Weapons*, RAND Corporation, April 2021, [https://www.rand.org/content/dam/rand/pubs/perspectives/PEA1000/PEA1015-1/RAND\\_PEA1015-1.pdf](https://www.rand.org/content/dam/rand/pubs/perspectives/PEA1000/PEA1015-1/RAND_PEA1015-1.pdf).

<sup>5</sup> 'After a hiatus of almost 18 months, in May 2019, North Korea resumed ballistic missile launches. Although abiding by its self-imposed moratorium on launching intercontinental and intermediate-range ballistic missiles (ICBMs and IRBMs), the DPRK has thus far conducted the initial launches of at least three new types of solid-propellant, short-range ballistic missiles (SRBMs). Despite the relatively short time since these launches began and the very limited information available on these systems so far, much of the coverage in the Western media has portrayed these new systems as having "significantly raised the country's [DPRK's] military capabilities," as "a marked improvement" in the North Korean missile threat to South Korea and Japan (including to US forces there)-and even an "immense danger." These fears are overblown. The launches of new SRBMs over past four months do not fundamentally change the balance of power on the Korean Peninsula and are highly unlikely to embolden Kim Jong Un to act more aggressively against the US or its allies in Northeast Asia. The deterrence that has prevented armed conflict on the Korean Peninsula for decades is as much of a reality today as it was a week, a year or five years ago. Concerns about these missiles resulting in a possible decoupling of the US-ROK alliance are unfounded.' Vann H. Van Diepen and Daniel R. DePetris, 'Putting North Korea's New Short-Range Missiles Into Perspective,' *38th North*, 5 September 2019, <https://www.38north.org/2019/09/vvandiependdepetris090519/>.

<sup>6</sup> See for example Adam Mount, *Conventional Deterrence of North Korea*, Federation of American Scientists, 2019, <https://fas.org/wp-content/uploads/2019/12/FAS-CDNK.pdf>.

graduated strikes and escalation management. North Korea is currently pursuing significant modernisation of its strategic arsenal,<sup>7</sup> with the development of intercontinental ballistic missiles (ICBM) equipped with high-yield nuclear warheads, meaning that it poses an increasing threat to the United States. The existence of this capability allows for a change in the arsenal's mission, particularly in the Korean theatre, and *de facto* allows Pyongyang to consider complex deterrence models.

Historically, most states that have built a nuclear deterrence capability have sought to prioritise the development of the strategic component before developing a non-strategic nuclear capability.<sup>8</sup> As a result, while non-strategic weapons – conventional or nuclear – contribute to deterrence, the mission assigned to the strategic arsenal and its intrinsic characteristics (such as the number of missiles, type and power of nuclear weapons, missile range, survivability and defence penetration capabilities) are decisive in defining the mission of the non-strategic component. Consequently, as soon as a strategic arsenal has the capacity to inflict unacceptable damage and is able to withstand a decapitation strike, it reduces or inhibits the enemy's ability to respond to tactical operations with strategic operations. In a context of mutual vulnerability – or, more precisely, one in which the asymmetry is such that a small nuclear power is able to impose a perception of mutual vulnerability upon a large nuclear power – non-strategic assets can conceivably be developed and provide greater flexibility in crisis management and escalation management.

In the latter case, the options likely to be chosen for tactical strikes or battlefield strikes remain difficult to anticipate. For a small nuclear power with a limited number of strategic delivery systems, such options may be chosen with the aim of generating a military effect on the battlefield through a strike on units or their logistic nodes, or they may be employed as part of a logic of de-escalation, either through a warning strike or the destruction of selected key sensitive targets. The primary political objective of this type of strike remains the cessation of hostilities or the securing of territorial or political gains. While the feasibility of this approach has been challenged, it is an established theoretical framework. The analysis becomes more complex, however, when a state has a nuclear capability *and* a capability for carrying out chemical strikes deep into enemy territory.

Current US doctrine does not rule out a nuclear response to the use of chemical weapons,<sup>9</sup> but such a response has generally only been considered against adversaries having at most a nascent non-strategic

---

<sup>7</sup> The definition of 'strategic' and 'non-strategic' is a complex matter, particularly in the case of ballistic missiles, as the concept of a strategic missile can be linked to its ability to strike deep in enemy territory and hit critical targets – thus reducing the definition of a strategic weapon to its range – but also to its ability to generate a massive effect – thus reducing the notion of a strategic weapon to a type of warhead, more specifically a non-conventional one. In the case of North Korea, however, the concept of a strategic missile can be misleading, as any missile launched from the country is capable of hitting strategic targets at extremely short ranges, while the use of WMD, including chemical weapons, is conceivable for both tactical (e.g. battlefield) and strategic (e.g. a critical target such as a population or economic centre) purposes. For the purposes of this report, a non-strategic weapon is defined as a conventionally or chemically armed weapon aimed exclusively at military targets within the South Korean theatre.

<sup>8</sup> For emerging nuclear powers, the notion of 'strategic component' is disconnected from the yield of the weapon, the range or the type of delivery system and is essentially correlated to the type of targets. A low yield nuclear weapon carried by a short-range delivery system, which could be defined as non-strategic for a major nuclear power, can be, for an emerging nuclear power, a strategic weapon. The subsequent development of weapons dedicated to the battlefield or non-strategic operations is a usual evolution, and is generally linked to the technology but also to the availability of the weapons.

<sup>9</sup> See, for example, the *2010 Nuclear Posture Review*, which explicitly says that states in breach of their non-proliferation obligations – essentially, North Korea – lay themselves open to non-conventional.

nuclear capability, and never against adversaries possessing a crude intercontinental capability that would expose US territory. North Korea's ability to use chemical weapons tactically (on the battlefield or on deep military targets) as well as strategically (for strikes on economic or population centres) and in the short term, the high probability that it will develop a similar capability for nuclear weapons, may lead the country to assume that a chemical attack would not necessarily be met with by US nuclear retaliation, especially if such an attack were not aimed at strategic targets. The potential to generate major military effects through a combination of conventional and chemical strikes may thus lead to North Korea's deterrence model shifting more towards coercion, by opening up strike options that would have tangible military effects without exposing the country to the systematic threat of a nuclear response.

The development of options for non-strategic WMD strikes has an obvious deterrent function, but their implementation nonetheless brings with it uncertainty as to the nature of the enemy's response. Consequently, the use of conventional options may seem desirable, especially as conventional strikes can be a part of aggressive sanctuarisation strategies. However, development of a conventional strike tool requires considerable technological and budgetary investment. Its effectiveness depends upon the amount of missiles available, their range, their precision, and their defence penetration capability, but also on the quality of intelligence, surveillance and reconnaissance (ISR) systems, and command and control (C2) capabilities. In the case of North Korea, while the development of effective missiles allows Pyongyang to consider developing certain limited conventional strike strategies, these will necessarily be closely linked to the strategy for the use of WMD, both in theatre and at the strategic level.

## 1.2 Elements of nuclear doctrine

North Korea's declaratory strategy, which had long been very vague, became more structured when Kim Jong-un came to power. This has been reflected in both the publication of a brief official document establishing an initial declaratory corpus in 2013,<sup>10</sup> of a much more detailed version in 2022,<sup>11</sup> and in the dissemination of general messages relayed by state media. Western analysts tend to judge this North Korean declaratory strategy rather negatively. Yet the construction of the country's nuclear discourse is consistent with that historically adopted by many emerging nuclear states. It is also typical of the choices made by nuclear states or nuclear alliances in a position of strong conventional and/or nuclear asymmetry in relation to their potential enemies, not to mention authoritarian states or those with aggressive ambitions. In this context, it comes as no surprise to see North Korea defining its capability as defensive while refusing to rule out pre-emptive options, and therefore the possibility of first strike.

---

retaliation(<https://www.foreignminister.gov.au/minister/marise-payne/media-release/joint-statement-australia-us-ministerial-consultations-ausmin-2020>). The *2018 Nuclear Posture Review*, meanwhile, specifies that US conventional and nuclear weapons are needed to target North Korea's hardened infrastructure, leaving little doubt as to the nature of the response should WMD be used (<https://media.defense.gov/2018/Feb/02/2001872886/-1/-1/1/2018-NUCLEAR-POSTURE-REVIEW-FINAL-REPORT.PDF>).

<sup>10</sup> See Law on Consolidating Position of Nuclear Weapons, cited in 'Law on Consolidating Position of Nuclear Weapons State Adopted,' *KCNA*, 1 April 2013, <https://kcnawatch.org/newstream/1451896124-739013370/law-on-consolidating-position-of-nuclear-weapons-state-adopted/>.

<sup>11</sup> See Law on DPRK's Policy on Nuclear Forces, cited in 'Law on DPRK's Policy on Nuclear Forces Promulgated,' *KCNA*, 9 September 2022, <https://kcnawatch.org/newstream/1662687258-950776986/law-on-dprks-policy-on-nuclear-forces-promulgated/>.

The Law on DPRK's Policy on Nuclear Forces<sup>12</sup> adopted by the Supreme People's Assembly in September 2022 removes certain uncertainties from the April 2013 version and provides greater clarity around the country's doctrine, particularly with regard to the missions of the arsenal, the command-and-control system for nuclear forces, and pre-emptive strikes.

The nuclear forces are tasked with safeguarding 'the sovereignty, territorial integrity and fundamental interests of the state, preventing a war on the Korean peninsula and in Northeast Asia and ensuring the strategic stability of the world'.<sup>13</sup> These 'fundamental interests' are not defined and the whole law aims to legitimise maximum flexibility in the use of nuclear weapons. Most importantly, in line with Kim Jong-un's April 2022 speech on the 'secondary mission' of nuclear forces,<sup>14</sup> it is clarified that while their primary mission is to deter war, their 'operational mission' is to 'repulse hostile forces' aggression and attack and achieving decisive victory of war in case its deterrence fails.' This development was explicitly put into practice in the exercises conducted at the end of September 2022, presented by the country as aiming to evaluate 'war deterrence and nuclear counterattack capability'.<sup>15</sup>

The command-and-control system for nuclear forces is clarified, particularly regarding the pre-delegation of launch authority. While the President of State Affairs has 'all decisive powers concerning nuclear weapons', it is specified that if the C2 system were 'placed in danger owing to an attack by hostile forces', which is a much vaguer term than 'neutralise', then 'a nuclear strike shall be launched automatically and immediately'. The aim is obviously to deter any decapitation strike, including conventional ones, against the regime and especially its leader.

The use of pre-emptive nuclear strikes is mentioned and the absence of any reference to a no-first-use policy indicates, by default, recognition of a first-use option. In the five scenarios for the use of weapons presented in Article 6 of the 2022 law, it is explicitly mentioned that they apply to cases of attacks launched or when an attack 'drew near is judged',<sup>16</sup> which was previously not mentioned in the 2013 law. The country is thus committed to using its nuclear weapons if it considers that its arsenal is about to be threatened or more broadly if the country's fundamental interests are about to be threatened. While questions obviously arise about the country's real early warning capabilities, this announcement in any case reinforces the risk of errors in the event of a false alarm or misunderstanding of US or South Korean intentions.

Eventually, North Korea offers a negative security guarantee, stating that it 'shall neither threaten non-nuclear weapons states with its nuclear weapons nor use nuclear weapons against them unless they join aggression or attack against the DPRK in collusion with other nuclear weapons states.' In theory, therefore, South Korea would not be a permissible target for a strike if the United States initiated a conflict without its consent and without the participation of its forces, but what about US forces and bases in South Korea? And while the law mentions an exception for the countries that 'participate in aggression or attack against the DPRK in collusion with other nuclear weapon states', one may wonder whether the very existence of the ROK-US alliance means, for example, that in the event of unilateral

---

<sup>12</sup> Ibid.

<sup>13</sup> Law on DPRK's Policy on Nuclear Forces.

<sup>14</sup> 'Kim Jong Un: Nuclear forces are for more than just preventing war,' *NK News*, 26 April 2022.

<sup>15</sup> 'North Korea trumpets training for "tactical" nuclear strikes,' *The Japan Times*, 11 October 2022.

<sup>16</sup> Law on DPRK's Policy on Nuclear Forces.

strikes by South Korea alone, particularly as part of their so-called Korea Massive Punishment and Retaliation (KMPPR) strategy, the country would be exposed to North Korean nuclear strikes?

### 1.3 Conventional options for reorienting the arsenal

North Korea's rhetoric and the development of the initial elements of a mutual vulnerability relationship with the United States (the high-yield nuclear weapon test on 3 September 2017 and the Hwasong-15 test on 28 November 2017) may suggest that North Korea could be focusing the development of its system of forces primarily on the nuclear component in both its strategic and non-strategic dimensions. However, it is not clear that such a shift would make its deterrence model more flexible. Despite its advances in nuclear technology, North Korea is still very much dependent on chemical weapons for the generation of deep military effects. As shown in Part II of this study, given the nature of its current arsenal, Pyongyang cannot envisage major effects on military targets without drastically limiting the number of targets involved and resorting to massive strikes. At the same time, while the short-range systems currently under development provide sufficient accuracy for conventional precision strikes, only massive use would enable them to generate a significant military effect. As such, North Korea does not yet have the capability to use conventional and chemical weapons in a selective and limited manner to produce a significant military effect. The development of nuclear capability thus provides additional deterrence but no additional flexibility.

In addition, whether considered in terms of a conventional, nuclear, or chemical perspective, any strategy based on the graduation of strikes from the tactical to the strategic level implies a capacity to manage the exchange. This requires the maintenance of secure communications with an arsenal that is resilient enough to remain operational despite enemy strikes. In addition to a high-performance and redundant C2 system, such an approach requires highly rigorous management of stockpiles and operations, maintenance of launch control, the ability to protect means of delivery during operations, and so forth. When conceptualising its operations, North Korea must also factor in the cataclysmic effects that both major conventional war and a nuclear exchange would have on its own force posture and the risk to its strategic systems, making the organisation of C2 particularly challenging. The issue of C2 and the resilience of the chain of command has led some to believe that the first use of nuclear weapons is more likely to consist of a massive strike in order to limit the risks associated with a counter-strike.<sup>17</sup> Although this hypothesis cannot be excluded, it would not, however, afford Pyongyang an opportunity to take advantage of the flexibility offered by multiple delivery systems and the increasing variety of payloads – nuclear, chemical and conventional – at its disposal.

At the time of writing it is very difficult to assess the extent to which modernisation of North Korea's ballistic missile arsenal and nuclear weapons will change the country's nuclear strategy. Similarly, it is uncertain whether the strengthening of its conventional strike or chemical strike capability might contribute to this change. However, the rhetoric of flexible response and the assertive development of non-strategic nuclear capabilities lends credibility to the risk of a strike and creates an additional rung on the ladder of escalation toward the use of WMDs. This option could be particularly attractive if the massive use of chemical weapons against military targets is to be considered, as it may mitigate the risk of a systematic US nuclear response.

---

<sup>17</sup> Choi Kang and Kim Gibum, 'A Thought on North Korea's Nuclear Doctrine'.

Conversely, it is clear that the development of a precision conventional strike capability and a militarily significant chemical strike capability is a key factor in political coercion scenarios in which North Korea exploits its conventional strike capability to threaten South Korea or even to carry out limited strikes against civilian and military targets. Scarcely conceivable even just a few years ago,<sup>18</sup> the idea of coercive ballistic missile strikes has become more credible since the Iranian strike against the US Al Asad air base in Iraq in January 2020. The Iranian attack was presented as a retaliatory action, but its coercive value is clear, not just on Iranian public opinion, but possibly also on the United States. It is difficult to establish at this stage whether Iran's action has caused a shift in US regional policy that will benefit Tehran, but it remains a replicable model that clearly demonstrates the value of precision strike systems for a minor military power in confrontation with a major one.

Given the nature of its arsenal, North Korea has so far been unable to adopt a coercive strategy on the basis of its ballistic forces, the core of its capacity relying on its ability to strike the Seoul-Incheon region with conventional and chemical artillery. But the prospect of the country adopting such a strategy generates significant uncertainty. In the past, it has engaged in particularly violent coercive actions without the threat of nuclear weapons,<sup>19</sup> relying instead on the interplay of alliances and a massive artillery capability in range of Seoul to sanctuarise its territory. In a context in which Pyongyang has a nascent strategic and non-strategic nuclear capability, without being able to say for sure that the development of a conventional arsenal capable of precision strikes would generate additional instability on the peninsula, it is nonetheless clear that this new capability would considerably expand Pyongyang's options. This is what the remainder of this report seeks to demonstrate.

---

<sup>18</sup> Political coercion scenarios were for a long time associated primarily with asymmetric action, limited armed confrontation between powers of equal standing, or punitive actions by major powers against a state in open violation of its international obligations.

<sup>19</sup> These include the attack on the Blue House in 1968, the attack and capture of the US navy ship *Pueblo* in the same year, the destruction of an American EC-121 over the Sea of Japan in April 1969, the destruction of a helicopter in the DMZ in September 1969, and the Rangoon bombing of 1983.



## 2 North Korea's short range arsenal

---

North Korea's short-range deep strike architecture has long been built around two families of missiles: the short-range Scud B (Hwasong-5) and Scud C (Hwasong-6) systems with ranges of 300 and 500 km, and the very short-range KN-02 (Hwasong-11/Toksa) systems with a range of between 120 and 170 km, which are domestic derivatives of the Russian 9M79 (SS-21A/OTR-21 Tochka) missile. As the KN-02s were produced later than the Scud B/C<sup>20</sup> there are fewer of them in North Korea's inventory, and they are rarely included in assessments of the country's strike potential. The Nodong and Scud-ER missiles, derived from the Scud B/C, are 'strategic' systems (on the scale of the country and the region) capable of striking the entire south of the peninsula and also Japan. The range of these two systems is generally estimated at 1000 km.<sup>21</sup> As strategic systems, they are not covered in this report. Moreover, their very low accuracy – over 1 km for the Nodong – precludes their use with conventional weapons against military targets, except if North Korea intends to use them in mass against a very limited set of infrastructural targets, leading to a rapid exhaustion of the stock.

The specifications of the Scud and KN-02 systems, which are relatively well known – although there is some uncertainty about the KN-02 – are shown in the table below (Figure 1). The accuracy of the weapons – or their circular error probable (CEP)<sup>22</sup> – remains uncertain; therefore current practice is to assume that North Korean systems have the same accuracy as the Soviet missiles (SS-1c and SS-21) from which they are derived. Both families of missiles can carry unitary conventional explosive charges or submunitions. Scud missiles have both chemical and nuclear capability, although the acquisition by North Korea of a warhead design suitable for carrying nuclear weapons is highly unlikely. The SS-21s deployed by Soviet forces had chemical capabilities,<sup>23</sup> but the export of chemical warheads to Syria, which is generally identified as the source of acquisition for North Korea, seems unlikely. Syria may have developed one and exported it to North Korea, or North Korea may have done the same with its own technology for the KN-02.

The estimates given for the KN-02 should be approached with some caution. The initial version, first flight-tested in 2004, is generally described as a clone of the SS-21A presumably acquired from Syria in the 1990s, with a range of 70 km.<sup>24</sup> However, the North Korean version is generally described as having

---

<sup>20</sup> The Scud B is believed to have entered production in North Korea 1987 and the Scud C in 1992. The KN-02 was declared operational by North Korea in 2006 and appeared in a military parade in 2007.

<sup>21</sup> The theoretical range of the Nodong is usually given as 1200 km, but the majority of tests have been carried out over distances of less than 1000 km. The reliability of the missile is also quite low.

<sup>22</sup> Circular error probable or CEP is a measure of the probability that 50% of the weapons will fall within the circle formed by the estimated accuracy radius of the weapon. In practice, longitudinal deviation (on the launch axis) tends to be greater than axial deviation, with a very small difference between the theoretical propulsion time for a given distance and the actual time leading to a significant longitudinal difference at the point of impact. The azimuthal deviation tends to be smaller, unless the missile is not fired from well-surveyed sites. Thus, although the CEP is described as a circle, it is more of an ellipse. The use of satellite location systems such as GPS greatly reduces the risk of error related to locating the firing site and also to locating the target once it is set.

<sup>23</sup> According to *Janes*, a warhead designated 9N123G may have been designed, consisting of 65 930g submunitions of VR (VX equivalent) nerve agent. See *9K79 Tochka/9K79-1 Tochka-U*, *Janes Strategic Weapon Systems*, 19 December 2017.

<sup>24</sup> This is the hypothesis put forward by Markus Schiller on the basis that the positioning of the KN-02's control surfaces is identical to that of the SS-21A and not to that of the B version. See Markus Schiller, 'Characterizing the North Korean Nuclear Missile Threat', Technical Report, RAND Corporation, 2017,

a range of 120 km, identical to the SS-21B, which is the same size but uses a more energetic propellant and a more modern terminal guidance system. If North Korea’s KN-02 is derived from the SS-21A, the payload of the KN-02 may be smaller than that of the SS-21A to achieve a 120 km range,<sup>25</sup> while the later versions tested in 2014, thought to have ranges of between 170 and 220 km, may differ significantly from the SS-21.

Figure 1. Russian SS-1c and North Korean current short-range ballistic strike systems

Designation	Photograph of the missile and launcher	Stages Type of propellant	Length Diameter Weight	Payload	Range and CEP
<b>SS-1c</b>		Single-stage Liquid	11.25m 0.88m 5860 kg	980 kg	300 km 900 to 1000 m
<b>Hwasong-5 Scud B</b>		Single-stage Liquid	10.94m 0.88m 5860 kg	980 kg	300 km 900 to 1000 m
<b>Hwasong-6 Scud C</b>		Single-stage Liquid	10.94m 0.88m 5860 kg	500 kg	500 km greater than 1000 m
<b>KN-02</b> (dimensions of the SS-21)		Single- stage Solid	6.4m 0.65m 2000 kg	482 kg	70 to 120 km 170 to 220 km Greater than 200 m

### 2.1 Size of the arsenal

Providing even an approximate assessment of North Korean’s missile stockpile is difficult. Multiple estimates from open sources place the number of Scud B and C missiles at around 500 to 600. The lack of differentiation between the two types of missiles in these estimates is in itself problematic, since they have very different payloads and CEP. As the rate of production is unknown,<sup>26</sup> these assessments remain

[https://www.rand.org/content/dam/rand/pubs/technical\\_reports/2012/RAND\\_TR1268.pdf](https://www.rand.org/content/dam/rand/pubs/technical_reports/2012/RAND_TR1268.pdf). Alexandr Khranchikhin also supports this view and estimates that the range of the KN-02 is similar to that of the SS-21A, at 70 km; see Alexandr Khranchikhin, ‘Sila Chuchhe’ [‘The Power of the Juche’], *Voyenno-promyshlennyj kur’er*, 18 May 2016, <https://www.vpk-news.ru/articles/30660>.

<sup>25</sup> Nonetheless, a 2008 transcript from the Missile Technology Control Regime (MTCR) describes the KN-02 as a missile having ‘a range of 120 km with a payload as large as 500 kg’. The authors may have extrapolate this data from that regarding the SS-21B.

<sup>26</sup> In 1999, South Korea estimated that the four identified Scud B/C production sites could produce around 100 missiles per year. Lee Sung-yul, ‘North Korea Operates at Least 4 Missile Factories, 10 Launch Sites, Official Says’, *Korea Herald*, 26 March 1999.

highly theoretical. Exports by North Korea, which were significant in the 1990s, have gradually dried up, and the production split between the Scud B and Scud C is unknown. Official US assessments<sup>27</sup> have consistently estimated North Korea's potential number of transporter erector launchers (TELs) to be less than 100 for the Scud B/C for the past decade, but with no indication as to the number of missiles.<sup>28</sup> The ratio between the number of TELs and the number of missiles estimated from open sources is relatively consistent with the ratios observed in other states using similar systems, usually around 3 to 4 missiles per TEL. From this point of view, a recent assessment cited by the International Institute for Strategic Studies (IISS) and Center for Energy and Security Studies (CENESS) based on Russian sources, which estimates the number of Scud B TELs at around 200 and the number of missiles at between 300 and 400, suggests an even lower TEL/missile ratio (1.5 to 2 missiles per TEL). Conversely, for the Scud C, the number of TELs is estimated at around 100, for 300 to 400 missiles. The total number of weapon systems in this assessment is therefore particularly high (300 TELs and 600 to 800 missiles), indicating a far higher TEL production capability than suggested by the US estimates.<sup>29</sup>

Although North Korea appears to have made progress in TEL design, this development is difficult to assess given its recent nature. The Scud B/C TELs appear to be based on former Soviet MAZ-543 vehicles, while the launcher for the KN-02, the first domestically produced launcher shown by North Korea in 2007, demonstrates basic engineering capability. The wheeled TELs identified in use with the KN-23 and KN-24 missiles may also have been imported, and bear a strong resemblance to MAZ-type vehicles. The tracked TELs, which complement the wheeled TELs for the KN-23 and KN-24 systems, are, however, more likely to be domestically produced and reflect a capability to adapt to unpaved terrain.<sup>30</sup> In addition, the adaptation of the KN-23A wheeled launcher, a heavier version than the one used for the original KN-23 (with the addition of an axle and modification of the cabin) demonstrates a capability to adapt the launcher to the missile, and thus, possibly, a local production capability for MAZ-type or similar TELs. However, although the IISS and CENESS studies seem to indicate North Korea is mass-producing these TELs, it is difficult to determine when this may have begun. The report of the Panel of Experts established pursuant to UN Security Council Resolution 1874 (hereafter referred to as the Panel of Experts) explicitly addresses this issue in its 2021 report. The document shows major infrastructure works on the Kusong Tank Factory (No. 95 Factory), which produces tracked TELs (including for the Pukgungsong-2 MRBM), and the March 16 Factory in Pyongsong, which produces wheeled TELs – associated with the Hwasong-14 and 15 ICBMs – but which could also be producing TELs for the KN-23 and KN-24.<sup>31</sup> The smaller KN-

---

<sup>27</sup> National Air and Space Intelligence Center (NASIC), *Ballistic and Cruise Missile Threat Report*, 2013, 2017 and 2020.

<sup>28</sup> More precisely, in 2013 NASIC estimated that there were fewer than 100 Scud B and C and KN-02 TELs in North Korea. Subsequent reports estimate the number of Scud B and C TELs only, at fewer than 100, with no estimates for the KN-02. See NASIC, *Ballistic and Cruise Missile Threat*.

<sup>29</sup> Alexandr Khranchikhin, 'Sila Chuchhe [The Power of the Juche]', *Voyenno-promyshlennyy kur'er*, 18 May 2016, <https://vpk-news.ru/articles/30660>; 'Raketnaya Programma KNDR: Dossie [The DPRK Missile Programme: A Dossier]', *TASS*, 29 November 2017, <http://www.tass.ru/info/4385973>; Presentation of General Victor Esin, Institute for the US and Canadian Studies, Russian Academy of Sciences, at the workshop 'Assessment of the DPRK's Missile Capability', CENESS, Moscow, 7 May 2018, cited in *DPRK Strategic Capabilities and Security on the Korean Peninsula: Looking Ahead*, Centre for Energy and Security Studies (CENESS, Russia) and International Institute for Strategic Studies (IISS, London), 2021.

<sup>30</sup> Some analysts, however, see the production of tracked TEL as a direct consequence of North Korea's inability to acquire wheeled chassis for TELs and not as a deliberate operational choice. See Melissa Hanham and Seiyon Ji, 'Advances in North Korea's Missile Program and What Comes Next', *Arms Control Today*, September 2017, <https://www.armscontrol.org/act/2017-08/features/advances-north-korea-missile-program-what-comes-next>.

<sup>31</sup> Panel of Experts established pursuant to resolution 1874 (2009), S/2021/211. The references given below for the reports by the Panel of Experts are listed by their code.

25 TELs could potentially be produced at another site. The significant expansion of both facilities tends to indicate growing national production capability.

Evaluating the number of missiles through counting TELs is therefore difficult to establish, as North Korea has had, in all probability, the ability to design TELs for a number of years. The consistency of the US estimates over the past decade, however, suggests that North Korea's industrial capability was limited until recent years. In the absence of stronger evidence, if we adopt the upper US estimate of around 100 TELs, and assume an upper figure of 5 missiles per launcher, then we can hypothesise that there are 500 *deployed* Scud B/C missiles in place. If the lower assumptions of the Russian researchers are used, the number of TELs would be 200 and the number of missiles 600. Russian sources estimate the number of KN-02s at around 100.<sup>32</sup>

## 2.2 Missile accuracy

### 2.2.1 Range and accuracy

Due to the very low accuracy of the Scud missiles, using them with conventional munitions is challenging. Although estimates of the Scud B's CEP vary, the value normally used has long been estimated by comparison with that of the Soviet SS-1c, which, in open sources, usually had an estimated CEP of around 300m at maximum range (300 km). The CEP of the Scud C, which has no equivalent outside North Korea, was later extrapolated from this and estimated at around 500 m at maximum range (500 km). Since the SS-1c/Scud B has a range of 300 km and the Scud C a range of 500 km, the rule of thumb was then applied that, for ballistic missiles equipped with second-generation inertial navigation systems, the missile's CEP is equivalent to 0.1% of its range.

This was, however, a very rough calculation, and over the past twenty years many assessments have estimated the Scud B's CEP at around 450 m. This value was put forward in an article published in the early 1990s by David C. Wright and Timur Kadyshev, who, based on various assessments by several experts who had worked on Iraqi systems after 1991, concluded that the CEP of the SS-1c and Scud B variants ranged from 450 to 1000 m at maximum range.<sup>33</sup> The lower end of this estimate, which has been consistently used in many evaluations for the Scud B,<sup>34</sup> yields a CEP equivalent to 0.15% of maximum range. Transposed to the Scud C, this gives an estimated CEP of 750 m at maximum range. In a major study on Scud missiles,<sup>35</sup> Steve Zaloga reports a longitudinal deviation of 600 m and an azimuthal deviation of 350 m for the Soviet SS-1c. If we take the value of 600 m, the CEP is approximately 0.2% of the maximum range, giving a CEP of 1000 m for the Scud C at maximum range.

However, these figures may not apply for the Scud B. If Wright and Kadyshev's empirical estimation is not taken as such but interpreted, the final estimation of CEP is slightly different.

---

<sup>32</sup> Khramchikhin, 'Sila Chuchhe'.

<sup>33</sup> The values used in this study are therefore median values and are indicative only. See David C. Wright and Timur Kadyshev, 'An Analysis of the North Korean Nodong Missile', *Science and Global Security*, n°4, 1994, <https://scienceandglobalsecurity.org/archive/sgs04wright.pdf>.

<sup>34</sup> The value of 450 m is still found, for example, in a joint publication by the Centre for Energy and Security Studies (CENESS, Russia) and in the International Institute for Strategic Studies (IISS), *DPRK Strategic Capabilities*.

<sup>35</sup> Steve Zaloga, *Scud Ballistic Missile and Launch Systems 1955-2005*, Oxford: Osprey Publishing, 2006.

If the CEP of the Scud B at maximum range is around 1000 km, then the range/CEP ratio is approximately 0.35% of maximum range. This value is close to that generally given for first-generation inertial navigation systems. Applying this ratio to the Scud C, the CEP of the missile at maximum range would be around 1.7 km.

But assuming that 450 m could be the CEP for a Scud B at minimum *operational* range, which could be around 100 km, the ratio would then be 0.45%. This figure is relatively consistent with Scud B data on long operational ranges – i.e. on *use* ranges, not *maximum* ranges – yielding a CEP of 900 m at 200 km. The ratio is also consistent with a CEP of 1000 m, this value being roughly equivalent to a range of 250 km, which would be a fairly typical credible range in *operational use* when the missile is used at long range. This value is also close to those observed for Iraq’s Al Hussein missiles.<sup>36</sup>

Figure 2. Potential CEP of the Scud B as a function of range/CEP ratio

		CEP (in metres) to range (in kilometres)					
		100 km	150 km	200 km	300 km	400 km	500 km
Range/CEP Ratio	0.2%	200 m	300 m	400 m	600 m	800 m	1000 m
	0.35%	350 m	520 m	700 m	1000 m	1400 m	1750 m
	0.45%	450 m	670 m	900 m	1350 m	1800 m	2250 m

The KN-02 missiles, which are derived from the Soviet SS-21, are sufficiently precise (owing chiefly to their very short range) that they are not limited to WMD use and can be used with unitary payloads and submunitions. Assuming that the system is derived from the SS-21A and not the SS-21B – and that it does not have a terminal guidance system – a CEP equivalent to that of the Soviet missile, i.e. 150 to 200 m at the shortest ranges (70 km) can be expected. At 120 km the KN-02 is likely to be less accurate. At longer ranges, which some recent versions of the KN-02 seem to offer (120 to 170 km, and even 220 km for a model tested in 2014), the CEP is probably much greater, unless the guidance and navigation system has been improved. However, with a precision of 200 m, these missiles are best used in salvo attacks, in combination with submunitions, or for strikes on large infrastructure targets or troop concentrations.

Attempting to accurately assess the CEP is key to considering possible North Korean strike strategies. Although the Soviet SS-1c was developed with nuclear or chemical strikes in mind, conventional munitions were also developed by the Soviets, indicating potential use for conventional purposes. If we take the CEP at maximum range, the systems seem to have a residual utility when coupled with conventional munitions and even a low utility when coupled with chemical munitions. Nonetheless, deployment of conventional warheads in the Soviet forces induces that an employment was considered feasible, which may induce that the missile was then used at very short range with conventional munitions and at short range with chemical munition. Such an approach may be replicated by North Korea.

<sup>36</sup> We note that at the end of the first Gulf War, the CEP of the Al Hussein, with a range of 550 km, was estimated at 3000 m.

## 2.2.2 Use over shorter ranges

Beyond deterrent strikes against civilian targets located deep in enemy territory, we should then anticipate Scud B and, less probably, Scud C missiles being fired at shorter ranges in order to make up for their low accuracy. At very short ranges, the adoption of depressed trajectories drastically limits both warning times and the risk of interception. For instance, at its minimum firing range (50 km), the SS-1c/Scud B's apogee is only 24 km for a flight time of 165 seconds.<sup>37</sup> Use at minimum range is, however, rare, as missiles operating so close to the front are highly vulnerable to attack.

The Scud B offers sufficient accuracy for potential conventional or chemical use against large infrastructure targets at short ranges in the order of 100 km to 150 km (with a CEP of 450 to 670 m for the lowest range/accuracy ratio considered here). The last known tests of the Scud B, conducted by North Korea in 2014,<sup>38</sup> were at ranges of 200 km, and may be indicative of the missile's operational range. This would therefore put the Seoul-Incheon region under threat from strikes on its population and economic centres. As we demonstrate later in this report, if the lowest range/accuracy ratio (0.45%) is retained, the feasibility of North Korean strikes at the supposed operational range on military sites using conventional or even chemical munitions is doubtful. It can be considered when fired in salvo at shorter ranges against non- or lightly hardened targets, either with unitary ammunition or submunitions.

There is no information on the modernisation of the guidance system of the Scud B (or the Scud C). Such modernisation would have involved a rather complex modification of the missile and would equate to a new version of it. Nonetheless, it is conceivable that North Korea improved its accuracy, the missile being rather useless at the 0.45% ratio considered here – except for terror strike with WMD. Therefore, a ratio of 0.2% or even 0.15% could be retained, since the accuracy of the missile would then be more coherent with the potential operational range that the tests may bring out. At 200 km, the CEP of a Scud B with a ratio of 0.15 would be 300 m, giving North Korea the possibility to target US and South Korean infrastructures and military assets up to the Pyeongtaek region, when firing from the first belt of Scud bases, located approximately between 50 and 70 km from the DMZ.

As shown in Part 2.3.1 (Figure 6) and 2.3.2 of this chapter, a CEP of 300 m is rather insufficient to target military infrastructures with unitary munitions, except if North Korea would accept the use of a dozen missiles to secure their destruction. Conversely, the use of area munitions such as submunitions or fuel-air explosives, with a large lethal radius, may be considered against specific targets. At very short range, when the CEP falls under 200 m, a less dense salvo of missiles (6 to 10 in the example given in Figure 6) using unitary munition would have a high probability of destruction of any given target (except sufficiently hardened or buried targets), generating vulnerabilities in the immediate depth of the DMZ.

Tests conducted in 2017 on an improved version of the Scud B with a manoeuvrable re-entry vehicle (MaRV), known as KN-21 in the US nomenclature, showed that North Korea intends to develop a more accurate version. The tests were conducted over ranges of 250 km in the Sea of Japan, making it difficult to assess the accuracy of this new missile. It is also impossible to say with certainty whether such modernisation is a possibility for the residual stock of Scud B missiles still operational within the North Korean military and whether it will allow a general upgrade of accuracy for these missiles. A MaRV version

---

<sup>37</sup> Steve Zaloga, *op. cit.*

<sup>38</sup> Data from the James Martin Centre for Nonproliferation Studies (CNS). The ranges of the previous detected Scud-B tests in 1984 are unknown.

associated with the Scud C, known as KN-18, has also been tested.<sup>39</sup> However, the current status of these programmes is unknown.

In parallel, the ranges identified from the recent Scud C tests exhibit the prevalence of a logic of long-range strikes, allowing for only coarse target discrimination. The CNS database<sup>40</sup> shows that the majority of Scud C firings – for which some telemetry data (range, apogee) has been provided – are launched at near-maximum ranges.<sup>41</sup> The tests therefore tend to show that the Scud C is still intended for use in the deepest part of South Korean territory, resulting systematically in very high CEPs, even if a low range/CEP is considered. Other than in the case of a warning strike or terror strikes, it would be combined with chemical munitions, likely targeting population centres or very large industrial sites. The use of nuclear munitions can also be considered here. The marked resumption of Scud C tests (15 launches between 2014 and 2021) indicates the major role still played by this missile in North Korean strategy. In contrast, only four Scud Bs were fired in 2014. Furthermore, in both North Korea and Iran, Scud system modernisation is usually based on the Scud C, demonstrating that the system retains an essential role owing to its range. In both countries, the modifications concern the guidance and navigation systems (Qiam and Qiam 2 in Iran, KN-18 and KN-21 in North Korea), highlighting the desire of these states to rely on the range of these systems but to broaden the spectrum of targets they can engage.

The prominence of the Scud C does not, however, mean that shorter-range weapons have no specific role to play. North Korea's interest in such systems can be seen in the KN-02 test campaign – 20 tests conducted between 2013 and 2015 – and in the very substantial KN-25 test campaign in 2019–2020, discussed in Part 4.3 of this study.

There is little information in the CNS database about the KN-02 test campaign, conducted entirely from the Hodo Peninsula test area, but its intensity suggests that it could have consisted of certification testing, possibly for a new model of the missile.

The KN-02 appears to be a relatively heavy modification of the 70 km-range SS-21A acquired from Syria. Initially, the increase in range from the basic SS-21A (70 km) to the first version of the KN-02, with a range of 120 km, could have been the result of a reduction of the payload (162 kg of explosive or 372 kg of submunitions), implying slight modifications to the missile. However, the extension of the range to 170 km cannot be the result of payload reduction alone. The possibility that the missile has larger dimensions than the initial version of the KN-02 cannot be excluded. It should also be assumed that work has been done to improve the guidance and navigation systems inherited from the SS-21A, which are very inaccurate (a CEP of 150 to 200 m for a range of 70 km), while the combination of a high CEP and a relatively light payload considerably limits the weapon's utility at maximum range. The potential 'new' CEP is unknown.

---

<sup>39</sup> Michael Elleman, 'North Korea's New Short-Range Missiles: A Technical Evaluation,' *38 North*, 9 October 2019, <https://www.38north.org/2019/10/melleman100919/>.

<sup>40</sup> The excellent James Martin Centre for Nonproliferation Studies (CNS) database is accessible online ('The CNS North Korea Missile Test Database', <https://www.nti.org/analysis/articles/cns-north-korea-missile-test-database/>) and is regularly updated. In some cases there are inconsistencies between missile ranges and apogees, with variations in the latter leading to variations in the former, which the database does not systematically reflect. However, the correlation between apogee and range is generally consistent.

<sup>41</sup> The only exception to this clear trend was a two-missile test in 2014 with a peak of 100 km, which would place the range at around 300 km.

The mission of the KN-02 remains difficult to define. The probable lightening of the payload limits the military effects that can be expected of the weapon, unless North Korea has been able to significantly improve its accuracy. The performance of the KN-23, KN-24 and KN-25 systems does not rule this out, but this would imply that North Korea is capable of manufacturing guidance and navigation systems in large numbers. If this is not the case, then the missile would have limited effectiveness in combination with conventional munitions. While use with chemical weapons is likely, the weapon’s inaccuracy means that its use can only be considered on a limited basis, due to its relative scarcity and the amount of munitions necessary for chemical operations on the battlefield (see Part 2.4 of this chapter).

### 2.3 Conventional payload types and possible effects

Obtaining a military effect – i.e. destroying or neutralising the target for a given period of time – depends on the ratio between the payload’s area of effect, or lethal radius (LR), and the CEP of the missile and on the resistance of the target to the effect of the payload. The LR of a given payload thus varies according to the target’s vulnerability to its effects. Assuming that the payload is suitable for the target, the LR/CEP ratio provides a rough estimate of the extent to which a missile can be used effectively against a given target type with this conventional payload. This rough calculation shows that, for all three types of missiles considered here, a conventional strike is not feasible, unless of course several missiles are combined on a single target and a payload with a large LR is used.

Figure 3. Theoretical area of effect of a missile as a function of Lethal Radius and CEP<sup>42</sup>

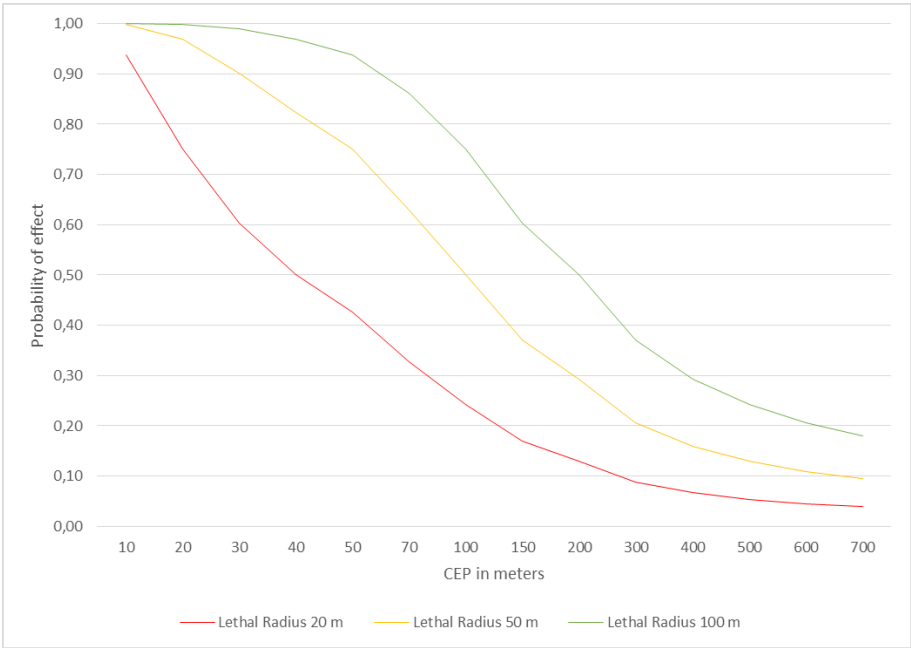

<sup>42</sup> The calculation used here is a ratio (single shot probability of kill, SSPK) between the LR and the CEP,  $SSPK = 1 - 0,5^{(LR/CEP)^2}$ .



Figure 4. Probability of effect with 2 (P2) and 3 (P3) missiles with a Lethal Radius of 50 and 100 metres<sup>43</sup>

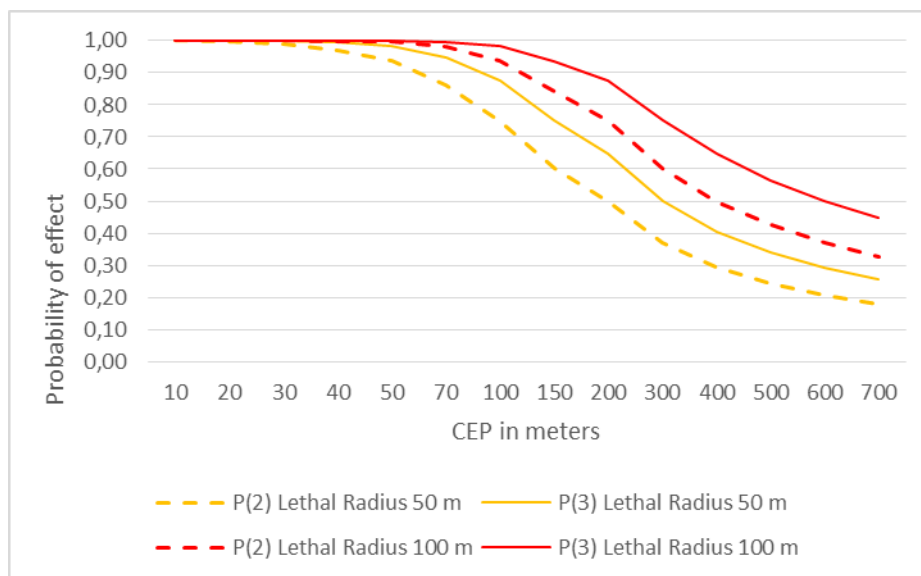

However, this approach remains theoretical in nature, as the LR can be significantly decreased if the munition is not suitable for the target. Thus, while a ballistic missile equipped with submunitions can have a considerable LR of 100 to 200 m, their use is limited to specific categories of targets, usually lightly armoured and non-hardened. Whereas vulnerable equipment (light armoured vehicles and equipment) can be neutralised with a single weapon, for some specific missions such as runway strikes, the need to ensure homogeneous damage over large distances may require the use of many munitions and therefore a large number of missiles to ensure neutralisation of the infrastructure. For unitary munitions as for submunitions, the LR is essentially indicative, and a more detailed assessment of the effects of ammunition is needed to understand the consequence of the strikes.

### 2.3.1 Effects of unitary munitions

Although the detonation effects of the conventional unitary payload of a Scud B are devastating,<sup>44</sup> its military effect is strictly correlated to the CEP. The 985 kg warhead carries 545 kg of explosive. At maximum range, the terminal velocity of the warhead on impact is estimated at 1.4 km/s, producing a crater 1.5 to 4 m deep and up to 12 m wide, depending of course on the terrain. The advantage of the Scud's large explosive payload lies mainly in its ability to produce a significant overpressure sufficient to damage buildings or equipment. A very simplified calculation, representing the peak overpressure caused by the warhead exploding at 15 m altitude, shows that an overpressure of 5psi/35Kpa is produced up to about 40 m, rising to 15psi/103Kpa at about 25 m. This range of values is generally used in assessing the LR of an explosive, as 5psi overpressure can cause damage to vulnerable equipment such as radar antennae or unarmoured vehicles, while 15psi is generally considered sufficient to damage

<sup>43</sup> The calculation used here is as follows:  $P_{(n)} = 1 - (1 - SSPK)^n$ , where P is the probability of the target being destroyed and n the number of missiles fired.

<sup>44</sup> During the Gulf War, the strike on the Dhahran Air Base on 25 February 1991, carried out by an Iraqi derivative of the Scud (the Al Hussein) with a payload half that of the Scud B, caused 28 deaths and 260 injuries.

lightly armoured equipment (such as TELs and self-propelled guns) as well as buildings and relatively heavy metal structures.<sup>45</sup>

Figure 5. Effect of detonating a 985 kg Scud B missile warhead with 545 kg of explosive at 15 m altitude from a given distance

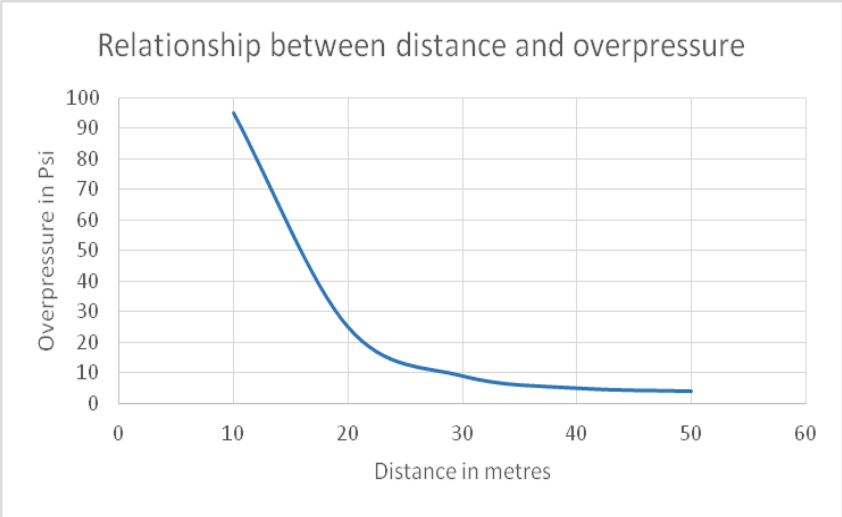

The use of unitary charges is preferred for the destruction of infrastructure. Even at short ranges, however, the difference between the CEP of a Scud (or a KN-02) and the distance in which the overpressure is sufficient for a unitary munition to generate a destructive effect on a given target is far too great to expect the target’s destruction. This makes it nearly futile to target individual military buildings. Nonetheless, as shown in Figure 6, at short range (low CEP), salvos of missiles fired at a given target are sufficient to give a rather high probability of destruction. Yet, the number of missiles needed to ensure the destruction of a single target would not allow more than several dozen areas at best to be targeted without rapidly exhausting the stock. Consequently, conventional strikes would probably essentially aim at the destruction of a very limited set of targets.

<sup>45</sup> The formula for calculating overpressure is the ratio of distance to explosive mass, in TNT equivalent correlated to the type of explosive (for TGAG-5, a multiplier factor of 1.4). The resulting figure is compared to a table of equivalences which is then used to work out the overpressure. Only peak overpressure has been taken into account here. See *Structures to Resist the Effects of Accidental Explosions*, UFC 3-340-02, Unified Facilities Criteria (UFC), 5 December 2008.

Figure 6. Probability of destruction of a target vulnerable to 25 psi of overpressure for 985 kg warheads (545 kg of explosive) used in salvo

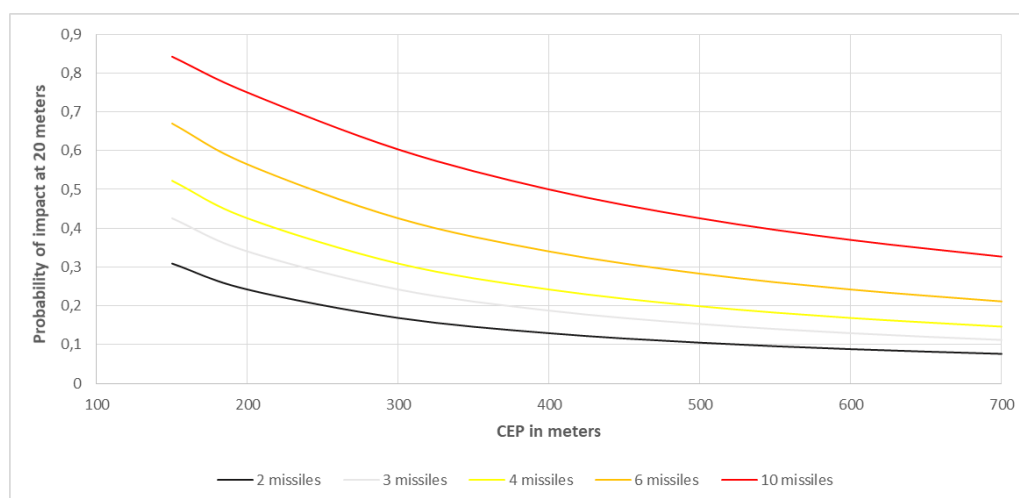

While strikes designed to produce economic damage could theoretically be considered in the event of a conflict, very large infrastructures could not be easily neutralised. If we take the example of the Joongbu thermal power plant, which produces a considerable share of Seoul’s electricity, the use of Scud B ballistic missiles operating at a 150 km range for a maximum CEP of 600 m would require several dozen missiles to be fired to ensure a military effect, and this may still be insufficient to ensure sustained interruption of production. Assuming that the entire site would be vulnerable, the effective target area would be approximately 9 hectares, while the missile would only have a 50/50 chance of impacting on an area of 180 hectares.<sup>46</sup> In case of a hit on any given element of the infrastructure, the missile would have to be within the lethal range to damage it. Neutralizing any critical element would be a matter of luck and could not be planned. Joongbu’s proximity to the demilitarised zone (DMZ) also would make it vulnerable to strikes by KN-02 missiles. Assuming a CEP of 200 m, the plant could be systematically hit by firing two missiles, but the destruction of critical sub-components could not be assumed with certainty, preventing the neutralisation of the power distribution capability with the use of such a small number of missiles. At long range, large infrastructure is practically immune to any strike. For instance, assuming a 1000 m CEP for a Scud B fired at maximum range targeting the Gunsan gas-fired power plant, which may supply the large US air base at Kusan and is the largest of the four power stations in the area, the missile would have only a 50/50 chance of hitting an area of more than 301 hectares, the power plant being less than 8 hectares in area.

<sup>46</sup> For a documented example of a strike on Saudi oil infrastructure, highlighting the importance of production subsystems in neutralising major infrastructure and ballistic system limitations, see Final Report of the Panel of Experts on Yemen, Prepared in Accordance with Paragraph 6 of Resolution 2456 (2019), S/2020/70, 10 January 2020; and for an analysis of oil infrastructure vulnerability, Itzkowitz Shiffrinson, Joshua R. Priebe and Miranda Priebe, ‘A Crude Threat: The Limits of an Iranian Missile Campaign against Saudi Arabian Oil,’ *International Security*, vol. 36, 2011.

Figure 7. Possible 600 m CEP for short-range use of a Scud B (red circle) and 200 m CEP for a KN-02 (yellow circle) relative to the area of the Joongbu LNG Plant (Seoul)



Credits: Google Earth/FRS

This very simplified assessment does not take into account the possibility of critical production subsystems being hardened, which would enable the infrastructure to rapidly get back on line or even to sustain the hit without any significant damage. A recent Israeli study<sup>47</sup> clearly illustrates the limits of ballistic missile strikes against such infrastructure targets when the missile's CEP is insufficient to guarantee an explosion within a few dozen metres. By evaluating the pressure resistance of industrial concrete,<sup>48</sup> the study shows that at distances greater than 20 m, 2 metres-thick walls offer satisfactory resistance to relatively heavy

loads (600 kg). Critical industrial structures, which are generally heavily concreted, are therefore essentially vulnerable only to direct hits and are likely to remain functional even in the event of a close impact. Vulnerability can be further reduced by burial or, for structures that cannot be buried, by the combined effect of protective measures.

### 2.3.2 Effects of submunitions

Over short ranges in particular, ballistic missiles are often combined with submunitions in order to destroy targets by generating an area effect, thus compensating for the delivery system's lack of precision or providing better coverage of area targets. The Soviet SS-1c is deployed in two known configurations with this type of payload: the warhead<sup>49</sup> can be equipped with either 100 5 kg fragmentation submunitions, giving the missile an LR of 150 to 200 m, or 42 12 kg runway penetration submunitions (the theoretical LR of the runway penetration munitions has not been identified). On the SS-21, the number of submunitions is only 50, with a unit mass of 7 kg, while nothing is known about existing Soviet runway penetration submunitions for this missile.

It is extremely difficult to assess the potential lethality of North Korean missiles coupled with submunitions, particularly because the types, numbers, and masses of submunitions used is unknown. Soviet cluster munition warheads were used with a relatively small number of bomblets but the mass of explosive carried by each device was rather high (1.2 kg for each 5 kg bomblet on the SS-1c warhead).

<sup>47</sup> Irad Brandys, *Integrated Blast Resistance Model of Nuclear Power Plant Auxiliary Facilities*, Faculty of Engineering Sciences, Department of Mechanical Engineering, Ben-Gurion University of the Negev, 2016.

<sup>48</sup> That is, BA30 and BA40 concretes, capable of withstanding pressures of 30 and 40MPa, *ibid*.

<sup>49</sup> In this configuration, the warhead of the SS-1c is designated 8F44K. *Former Warsaw Pact Ammunition Handbook, Volume 2, Land Forces Ammunition, Rockets and Missiles*, NATO Explosive Ordnance Disposal, Centre of Excellence, Slovak Republic, 2015.

Since the late 1980s the United States has been using dual-purpose submunitions (anti-personnel and anti-material, known as APAMs), which are lighter but higher in number. The MGM-140 heavy guided rocket, in its initial version, carries 950 M74 submunitions, which allows it to cover approximately 150x150 m of terrain. Thus, while the area covered by the MGM-140's submunitions approaches that of the Soviet SS-1c (i.e. an LR between 160 and 250 m), the density of the dispersed munitions is far higher. As a result, the probability of a target being damaged by the detonation of one or more dispersed munitions in its immediate vicinity is far higher than when the same target is targeted by the submunitions of an SS-1c.<sup>50</sup> Modification by North Korea of the submunitions carried by the Scud B or KN-02, for example by reverse-engineering US M74 submunitions, or designing smaller bomblets of its own, could therefore increase its ability to hit certain targets.

An evaluation of the potential of these systems based on a theoretical LR clearly shows that an LR of 150 m enables the use of relatively inaccurate missiles to be considered. According to this graph, firing four missiles with a 600 m CEP but coupled with a payload that has an LR of 150 m would hit the intended target in 80% of cases. Firing four missiles with a 200 m CEP and that LR would ensure an almost certain hit. Knowing that a rather wide range of targets is likely to be envisaged (anti-aircraft and anti-missile batteries and supporting radars, towed artillery, logistics points, dense concentrations of equipment in unprotected areas), these figures show that North Korea could make limited use of such ballistic missiles in a conventional configuration.

Figure 8. Probability of the target falling within the area of effect as a function of LR and CEP

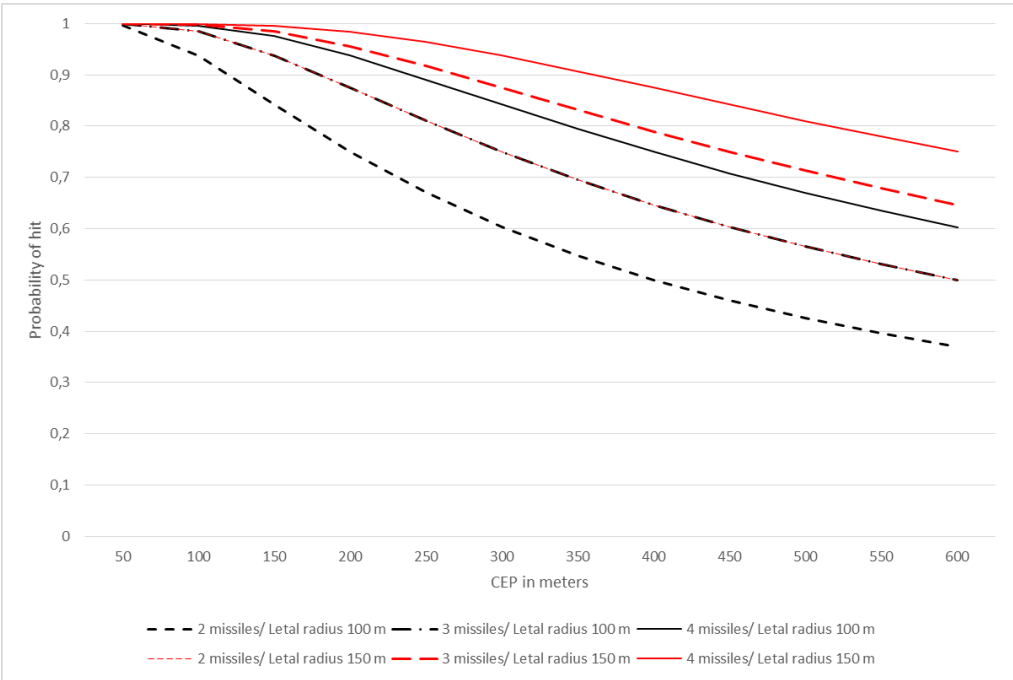

The use of fuel-air explosive (FAE) munitions, which can also cover areas of several dozens of metres, could also be envisaged, but the dispersion of FAE from a ballistic missile is poorly documented and will

<sup>50</sup> The radius of effect of the M74 submunition is about 15 m.

not be described here. There is, however, renewed interest in this type of explosive, and it is generally well suited to tactical strikes.

The effectiveness of a missile armed with submunitions against equipment, (parked aircrafts, non-hardened buildings, storage area) can be evaluated using a relatively simplistic calculation,<sup>51</sup> but which becomes more complex when considering a runway strike. Should the United States or South Korea be the target of a strike out of the blue, numerous areas could be targeted with Scuds or KN-02s deep within the DMZ. Nonetheless, for North Korea, neutralising South Korean and US air bases would be essential and the existing arsenal may prove unsuitable to such a mission.

The use of submunitions for runway strikes can only partially make up for the inaccuracy of a given missile. This is because the submunitions must be dispersed in such a way that a sufficient number of them hit the runway, with a distance between impacts that does not exceed the minimum distance needed for an aircraft to take off. In an assessment of the number of missiles needed to damage two runways of 50 m in width and 1500 m in length that can be used by fighter-bombers, a study on the assessment of the strike capabilities of India’s Prithvi missile<sup>52</sup> shows that a missile carrying 70 heavy runway submunitions<sup>53</sup> requires a disproportionately large number of missiles, even with a ‘low’ CEP (150 m). This is due to the fact that partial neutralisation of the runway is unlikely to generate any tangible military effects if aircrafts can still take off. The potential effect of any strike can also be mitigated, especially when the runway can quickly be resurfaced. This example shows that Scud and KN-02 could not be used for such missions. However, striking bases with submunitions in order to impede activities and delay air operations remains an option, notably against these located in the vicinity of the DMZ.

*Figure 9. Probability of neutralizing an air base with two 50 x 150 m runways using 10 kg runway submunitions*

CEP	Probability of hitting the target	Probability of damage	Number of heads per 400 m x 50 m runway segment	Number of missiles per air base (2 runways)
150 m	0.112	0.089	32	256
250 m	0.058	0.046	64	512
300 m	0.043	0.035	84	672

## 2.4 Chemical strikes on military targets

Due to the serious limitations of conventional munitions, in the context of a conflict rather than a simple warning strike, the pursuit of enduring effects on military targets would require the use of munitions with a significant and lasting area effect, i.e. chemical or biological weapons. An assessment of the use

<sup>51</sup> For instance, for an analysis on the use of submunitions against parked aircrafts, see John Stillion and David T. Orletsky, *Airbase Vulnerability to Conventional Cruise-Missile and Ballistic-Missile Attacks. Technology, Scenarios, and U.S. Air Force Responses*, MR-1028-AF, Rand Corporation, 1999.

<sup>52</sup> Z. Mian, A. H. Nayyar and M. V. Ramana, 'Bringing Prithvi Down to Earth: The Capabilities and Potential Effectiveness of India’s Prithvi Missile', *Science & Global Security* 7 (1998). It should be noted that this assessment used very strict criteria for runway neutralisation, with the authors estimating that the runway would have to be hit every 400 m along its entire length, and every 10 m across its width, in order to prevent fighters from taking off on an interception mission.

<sup>53</sup> This model is based on the Prithvi payload, but the SS-1c carries 100 submunitions of identical mass, meaning that the two systems can be regarded as roughly comparable.

of biological weapons is not included in this report, owing to the lack of data on the delivery of biological agents *via* ballistic missile systems.

While the use of chemical weapons increases the LR of a warhead and compensates for the inaccuracy of a missile on large unprotected targets (population or economic centres for instance), for a strike on a military target (base, logistics centre) the effect can only be obtained by incapacitating sufficient personnel or contaminating the areas where functional operations take place, in particular equipment maintenance, ammunition loading and refuelling areas.<sup>54</sup> A minimum accuracy is then required if any effect on military operation is expected. Chemical weapons can also be used against troop concentrations and employed for the purposes of area denial or paralysis, but the amount of chemical agent needed is very high. As such, North Korea would likely use chemical weapons in different ways depending on the nature of the targets: by artillery (including multiple rocket launchers); against units on the battlefield, immediately behind the lines and in areas bordering the DMZ; and by ballistic missiles, against infrastructure located deep in the enemy territory.

For artillery strikes on the battlefield, density of fire makes it possible to generate relatively precise effects, as commanders will generally have sufficient information on the location of the targeted units, the nature of the terrain and meteorological variables. Using multiple firing assets also enables more homogeneous distribution of toxic agents, making it possible to cover larger areas more precisely and effectively. Beyond battlefield strikes, infrastructure targets such as Camp Casey, Camp Castle and Camp Hovey, previously home to US Army units, located between 20 and 40 km from the DMZ, were typically the type of logistical infrastructure likely to be targeted by conventional or chemical artillery strikes. Gradually abandoned in favour of Camp Humphreys, located at the centre of the peninsula, such potential targets are becoming rarer, with Camp Casey being one of the last major US infrastructure sites currently still within range of North Korean artillery (apart from the large multiple rocket launchers currently entering service). The relocation of this infrastructure reduces the vulnerability of US forces but does not alter the threat to South Korean forces positioned along the DMZ. The impact of such strikes on combat units should not be overlooked, as a combination of the disruption of the force posture on the battlefield with deep strikes on logistical infrastructure and air bases is likely to generate tangible military effects.<sup>55</sup> The qualitative strengthening of South Korean infrastructure in the DMZ over the past decade should,

---

<sup>54</sup> In the 1990s, when the use of chemical weapons was at the top of the US Army's agenda, doctrine document FM 3-100 estimated that, beyond the battlefield, the targeting strategy would likely be as follows: 'Developing nations' adversaries who follow former Soviet doctrine, with adequate stocks of chemicals, will likely use persistent chemical agents to restrict air base and port operations. Persistent nerve and blister agents will slow or stop the servicing of aircraft and ships and hinder cargo handling. Persistent agents on logistics facilities will impair resupply and service operations. It will seriously delay medical care and the use of pre-positioned stocks.' FM 3-100 3-3.7.1vs., 1996, <http://www.fas.org/nuke/guide/usa/doctrine/army/fm3-100/CH1.PDF>.

<sup>55</sup> FM 3-100 states that '[t]he nature of the direct fire battle changes dramatically (under NBC conditions) [...] It takes the platoon almost twice as long to complete an attack and, even though the battle is much less intense firing rates decline by 20% in the defence and 40% in the attack), nearly twice as many men are required for a successful attack. The number of casualties suffered per enemy defender killed increases by 75 %. APC losses double [...] Of those shots fired, almost 20% are fired at friendly personnel (fratricide) [...] It is more difficult to locate targets accurately and radio calls for fire take longer [...] Leaders at all levels indicated that they did not have time to accomplish all their duties (because of added duties such as supervision of NBC activities) [...] Leaders reported severe degradation in their ability to direct fire and maneuver [...] Communications were degraded by at least 50% [...] transmission times during the battle increased by more than 100% [...] the number of camouflage actions decreased by 39% (as fatigue and frustration overcame sound tactical practices)' (ibid.). Note however that this assessment covers all types of non-conventional munitions, and not specifically chemical weapons.

however, reduce this vulnerability, since most bunkers have probably been designed to offer adequate protection against chemical weapons.

For North Korea, the situation is more challenging for ballistic missile chemical strikes, even when targeting relatively large military infrastructure (air bases or Camp Humphreys, where half of the relocated US troops are usually concentrated in peacetime). Strikes against this type of target are primarily designed to neutralise personnel (paralysis strike) in order to reduce their operational potential rather than to kill them. However, the dispersion of toxic agents *via* missiles can only cover limited areas and will vary depending on weather conditions and the altitude of dispersion, but also on the viscosity of the type of agents used (sarin, soman and tabun are generally preferred to optimise coverage; VX is suitable only for smaller areas, but is far more persistent).

According to a RAND study, a Scud B missile using 500 kg of chemical agent<sup>56</sup> would expose 50% of unprotected persons to a 50% mortality risk over an area of 0.8 km<sup>2</sup> for a sarin agent and 0.3 km<sup>2</sup> for a VX agent.<sup>57</sup> Protected personnel would be exposed to a mortality risk of around 5%. Dispersion of chemical agents takes the form of an elongated ellipse, with coverage being far greater in the direction of the wind (across the length of the ellipse) than in the transverse direction (across the width of the ellipse). Sarin is dispersed over an area almost 2 km long and 500 m wide, and VX over an area that is greater than 2 km in length but only about 200 m wide. It should be noted that the dispersal area for VX from an SS-1c missile is reported to be 4 km by 600 m by some sources.<sup>58</sup> Although these are not negligible areas, attempting to accurately target an area by ballistic missile is challenging, as the chemical agent is typically not sprayed on and near the target area, but diffused from the point of detonation of the warhead and then dispersed downwind toward the target area. The inaccuracy of the warhead is a major limiting factor here, especially for the Scud C with its higher CEP and a far lower VX payload than the Scud B.

While sarin and soman agents are more easily dispersed, their effect is relatively short-lived, meaning that light protective clothing can be worn and decontamination is relatively easy. Persistent agents such as VX are generally preferred for paralysis strikes because they remain active over a long period of time (two to three days for VX) and are highly lethal. This type of agent requires full chemical suits to be worn over a long period, and rigorous decontamination procedures that compromise operational readiness.

The authors of the RAND study estimate that the use of an initial missile strike with a high-coverage agent (such as sarin) followed by a strike with a missile carrying a persistent VX-type agent against each of the ten bases then used by US forces in South Korea would generate a permanent paralysis effect on the target, significantly reducing operational readiness. The authors estimate that the use of 300 Scuds would severely constrain the entire posture for the following 30 days. This figure represents the minimum number of devices needed if each ballistic missile were able to hit the target at a point where the toxic agents could effectively hit the base in the desired area. Since this is not possible given the

---

<sup>56</sup> This volume corresponds to the chemical agent load carried by a Soviet SS-1c. The authors assume ordinary meteorological parameters for the region (21°C, very low wind speed, etc.). The detonation altitude varies between 50 and 200 m depending on conditions. The concentration of chemical agent inside the ellipse generates a lethality of 51% on unprotected personnel. See Brian G. Chow, Gregory S. Jones, Irving Lachow, John Stillion, Dean Wilkering, and Howell Yee, *Air Force Operations in a Chemical and Biological Environment*, Documented Briefing, RAND Corporation, 1998, [https://www.rand.org/content/dam/rand/pubs/documented\\_briefings/2007/DB189.1.pdf](https://www.rand.org/content/dam/rand/pubs/documented_briefings/2007/DB189.1.pdf).

<sup>57</sup> Ibid.

<sup>58</sup> Steve Zaloga, *op. cit.*



accuracy of Scud systems, the number of missiles needed to strike each infrastructure target would be considerably higher, even at relatively short ranges. The use of the Scud C, which can reach US bases in the centre of the peninsula but has a far lighter payload, would be of little use against them, unless it is employed extremely heavily against a single target.

Beyond the limitations of the missiles themselves, many other factors contribute to the challenges of planning a chemical strike. The size of some infrastructure targets would require several strikes in order to neutralise all functional areas of the base. Furthermore, the strengthening of passive defences requires the use of higher density agents and therefore more missiles per target. In 1975, official US sources estimated that a tenfold increase in the dosage of VX-type agent was required to generate a 50% LR to a person wearing protective equipment as compared to unprotected personnel.<sup>59</sup> Improvements in protection and decontamination along with the increase in treatment options therefore contribute to significantly reducing the vulnerability of targets to this type of attack. Furthermore, the calculated effects can be strongly limited by weather conditions (such as humidity, heat and cloud cover).

RAND's estimate is, however, a good indication of the *minimum* force required, especially if the weapons system used is significantly more accurate, as could be the case if North Korea is able to mass-produce the short-range missiles it is currently developing. As it stands, however, given the uncertainty as to the accuracy of the missiles that might be used, the study would suggest that North Korea cannot envisage a deep ballistic missile chemical strike on the entire military infrastructure and would probably be forced to focus on a much more limited set of targets. This assumption should be relativised if the accuracy of the Scud B is better than expected in this study (300 m for 200 km for instance). On this hypothesis, the aim would be not so much to generate significant personnel losses as to impair their operational capability and introduce confusion and delay. However, the development of missile defences generates greater uncertainty about the actual effect of the strike, as the interception of one or more missiles can significantly alter its predicted effects. Depending on their estimated efficacy, defences may become priority targets and may justify the allocation of additional weapon systems to neutralise them. Since the systems are designed to operate in a chemical environment, rendering the defences inoperable would require over-concentration of toxic agents or the use of conventional munitions.

Even if North Korea has – with its current arsenal – the capacity to carry out massive chemical strikes deep in South Korea's territory, the build-up of passive and active defences is gradually eroding its capability to durably impair South Korea and the US ability to pursue operations. Seeking to obtain an effect, even on a very limited number of targets, would require massive salvo attacks, compelling North Korea to focus on specific targets. Moreover, such attacks would have a cataclysmic impact on the areas surrounding the military bases, amounting to a terror strike. Such an effect may be considered as acceptable or even attractive in an all-out conflict. It would, however, be counterproductive in a scenario where Pyongyang wishes to use its deep strike chemical capability while trying to avoid the risk of uncontrolled escalation. Harassing fires against a wider set of targets could also be considered, but the increasing effectiveness of missile defences against Scud-type missiles could substantially mitigate their impact on operations.

---

<sup>59</sup> That is, from 100 milligrams per minute per cubic metre ( $\text{mg}\text{-mn}/\text{m}^3$ ) to  $1000\text{mg}\text{-mn}/\text{m}^3$ . For a more volatile soman agent, this ratio is  $100\text{mg}\text{-mn}/\text{m}^3$  to  $10,000\text{mg}\text{-mn}/\text{m}^3$ . See FM 3-9, *Military Chemistry and Chemical Compounds*, Department of the Army, 1975.

On shorter ranges, the use of chemical weapons could remain suitable for operational strikes on the battlefield using artillery and possibly very short-range ballistic missiles of the KN-02 type. Such operations are, however, challenging. In 1991, the US Office of Technology Assessment<sup>60</sup> noted that a tactical strike imposed particularly heavy constraints, estimating, for example, that to cover 1.3 km<sup>2</sup> of land in order to attack an infantry position, no fewer than 216 240 mm artillery rockets, each carrying 8 kg of sarin, would be necessary, and that contamination of a strip of land 60 km long and 300 m wide by a VX-type agent would require 65 tonnes of chemical agent fired by 13,000 155 mm shells. This type of operation, which is logistically very complex, represents a real risk, as it can be detected by the opposing forces and result in pre-emptive strikes and protection strategies on the front line and dispersion behind the lines.

The difficulties involved in organising a chemical strike designed specifically to achieve a military effect and the discontinuity between battlefield operations – where chemical strikes would necessarily impact on the course of the fighting – and deep strikes – where military effects can mostly be anticipated through massive use – raise questions about North Korea’s possible strategy in other scenarios than an all-out conflict. Although intermediate options could be considered, such as localised strikes for warning purposes, the existing arsenal offers minimal flexibility. In the event of a limited conflict, where North Korea would seek to avoid a rapid and uncontrolled escalation, Pyongyang has only a limited set of options. The inability of its current ballistic arsenal to generate a military effect on deep targets without resorting to massive chemical strikes means that North Korea cannot hinder the build-up of the US and South Korean force posture, while not using chemical weapons on the battlefield exposes the North Korean armed forces to a rapid loss of initiative and tactical defeat in the short term. Conversely, the use of chemical weapons on the battlefield can only have a lasting military effect if completed by massive chemical strikes against major military infrastructure, in order to slow down the US and South Korean reinforcements, effectively resulting in terror strikes and a paradigm shift in the continuation of hostilities. These limits do not mean that North Korea cannot wage a war, nor that chemical strikes would be useless, but that the existing delivery systems are not suitable and would restrict the operational options in a conflict Pyongyang wishes to contain.

As such, it cannot be ruled out that the development of missiles suited to precision strikes and capable of penetrating defences may be designed to provide a greater range of options for North Korea. Restoring a chemical strike capability against military infrastructure could thus have two objectives: to have a significant impact on enemy operations, and to create a real escalation step by distinguishing chemical strikes for military purposes from strikes for the purposes of terror and mass destruction. It should, however, also be considered that chemical operations would take place in a context in which North Korea has demonstrated its willingness to deploy tactical nuclear weapons. South Korea and the United States would thus be faced with different logics of escalation, in which chemical strikes might represent only an intermediate step.

---

<sup>60</sup> U.S. Congress, Office of Technology Assessment, *Proliferation of Weapons of Mass Destruction: Assessing the Risks*, OTA-ISC-559, 1993, <https://fas.org/sgp/othergov/doe/lanl/ota-isc-559.pdf>. This study is largely based on the work of Victor A. Utgoff, *The Challenge of Chemical Weapons*, New York: St. Martin’s Press, 1990.

## 2.5 Adapting the strike system to the threat from the United States and South Korea

The amelioration of the CEP of its missiles is obviously not the only element being considered by Pyongyang in the definition of its future SRBM force, which had to factor in at least two major developments: the evolution of South Korean and US offensive capabilities, and the growing role of missile defences. These developments, which took place at a time when North Korea's short-range arsenal was undergoing an initial stage of improvement, are likely to have profoundly influenced the specification of future systems.

### 2.5.1 The modernisation of the deep strike capability of the United States and South Korea

Although the US force posture in South Korea underwent a major evolution after the Cold War with the withdrawal of the nuclear weapons deployed in the country, US forces continued to have a significant presence, with between 35,000 and 45,000 troops stationed there during the 1990s and 2000s. In addition, the transformation of the operating methods of US forces, highlighted by the conflicts in Iraq and Afghanistan, as well as the continual modernisation of weapons systems and their architecture, have profoundly changed the balance of forces on the peninsula.<sup>61</sup>

Since the end of the 1990s, four major elements have become apparent in the transformation of US forces: the increasing performance of command, intelligence, surveillance and reconnaissance (C4ISR) systems, the transformation of strike capabilities through the increased use of precision munitions, and, as a corollary to these two developments, the development of strategies for destroying opposing ground assets at the earliest stage of the conflict and the restoration of a manoeuvring capability for US forces.

Since the 2000s, from bases in South Korea and Japan, the United States has deployed a density of C4ISR assets that is unrivalled anywhere in the world, either permanently or on a rotating basis (U-2, RQ-4, RC-135, E-3, E-8, to mention only the heavy platforms), reinforced by the space-based infrared system (SBIRS) and naval and land-based surveillance<sup>62</sup> and electronic warfare assets. The combination of these C4ISR assets, the modernisation of munitions (such as JDAM, TLAM, MRLS and ATACMS), their more systematic allocation, in the case of air-to-ground missiles and ammunition, to heavy strategic platforms (B-52, B-1 and B-2) and their availability to the US command in Korea and to Pacific Command, have all considerably increased the lethality of US forces in the area. Moreover, the US forces stationed in South Korea remain on the highest alert level and would be fully operational on a very short time frame.

In this context, the adaptation of South Korean strike capabilities should also not be overlooked. In the 1990s, South Korea's armed forces began to shift their force posture towards a more agile and efficient model, in particular by modernising their artillery systems, armoured vehicles and communication systems. They also initiated the first studies on the development of Hyunmoo B and C ballistic missiles.

---

<sup>61</sup> On this, see the brief but useful summary by Joseph S. Bermudez Jr., 'Lessons Learned from Foreign Conflicts 1960-Present, Part II 1,' *KPA Journal*, vol. 1, n°10, October 2010, <http://static1.1.sqspcdn.com/static/f/716134/9902705/1292881445790/KPAJ-1-10.pdf>.

<sup>62</sup> No fewer than 3 AN/TPY-2 radars currently cover the North Korean peninsula, i.e. 27% of overall existing American capacity, to which must be added Japan's not inconsiderable resources.

However, it was not until the mid-2000s that the South Korean forces began a more profound transformation, notably through a series of organisational reforms. The sinking by North Korea of the Cheonan corvette in March 2010 appears to have been a key moment in this respect, leading South Korea to place more emphasis on the development of an offensive strike capability and high-performance C4ISR system. The various Hyunmoo 2 models now provide Seoul with strike options very deep into enemy territory, while the development of the KTSSM heavy guided rockets,<sup>63</sup> which complement the ATACMS heavy guided rockets already deployed by the United States and South Korea on the peninsula, should in the near future allow for bunker and tunnel strikes on facilities bordering the DMZ. In parallel, strike strategies have been developed (Kill Chain and Korea Massive Punishment and Retaliation), essentially designed to conduct precision strikes and decapitation capabilities deep into North Korea's territory, even without US assistance.<sup>64</sup> The operations in Ukraine also show that tactical drones and loitering munitions will considerably enhance the United States and South Korea's strike capability against opportunity targets, and notably against TELs.

These developments have created a particularly significant threat to the majority of North Korean strike systems, which are based on the Scud and Nodong liquid-propellant missiles, whose propellants cannot be stored in the missile for periods beyond 90 days<sup>65</sup> and which require firing preparation procedures when unfuelled that can take over 30 minutes.<sup>66</sup> Deploying these missiles also requires significant logistical support, which makes them easier to detect. Lessons learned from the conflicts in which US forces have been engaged since 1991, along with the operational demonstration of the vulnerability of military equipment to deep air strikes, logically encouraged North Korea to develop solid-propellant systems as early as the 1990s. A sign of this transition can be seen in the acquisition of the SS-21 from Syria in the mid-1990s and the development of an industrial sector to enable construction and development of its national version (KN-02). At the same time, Pyongyang has established initial production capability for composite solid propellant, putting it on a path to producing more efficient systems. North Korea did not stop the development of liquid propellant technology, but abandoned it for short-range missiles. The likely termination of Scud B production and the absence of development of any liquid fuel SRBM with storable propellant confirms this hypothesis.

---

<sup>63</sup> The KTSSM is a heavy guided rocket, dedicated to counter-strikes against short-range ballistic systems and artillery. It is set to come into operation from 2022. It is complemented by the K239 multiple rocket launcher which operates at shorter ranges. These two systems complement the South Korean's US-origin ATACMS and GMLRS as well as the ATACMS and GMLRS deployed by the US Army.

<sup>64</sup> For an excellent summary, see Joshua H. Pollack and Minji Kim, 'South Korea's Missile Forces and the Emergence of Triangular Strategic (In)stability,' *The Nonproliferation Review*, 2020.

<sup>65</sup> It should be noted that one of the innovations in the Soviet SS-1c was the modernisation of the missile's propellant tanks to allow for long-term storage. Steve Zaloga reports that the modification of the tanks enabled them to be stored for 90 days. It is likely that North Korea's missiles have been similarly upgraded (Steve Zaloga, *op. cit.*)

<sup>66</sup> While underground launch sites have been identified in Iran, none have been identified in North Korea, where detected Scud garrisons are housed day-to-day in tunnels but do not appear to have capability for being fired from underground there. Those North Korean deployment sites known via open sources appear to be organised around enclosed storage sites, along with dispersed firing points on their periphery. Nonetheless, in case of conflict, it may be assumed that missiles would probably be fuelled in their underground storages and dispersed on their wartime launch sites. Their vulnerability is therefore limited and would depend on the United States' ability to detect the activation of the arsenal and to track the systems during their dispersion.

## 2.5.2 Impact of the development of missile defences on the technical choices of North Korea

At the same time, the deployment of the first missile defence capabilities in Korea, which were introduced in 2004 with the arrival of the first US Patriot PAC-3 endo-atmospheric interceptor batteries to replace the six PAC-2 and PAC-1 batteries already in place, required North Korea to rethink the development of its future arsenal. Complemented by the deployment of the SM-3 exo-atmospheric interceptor systems to US forces in the Pacific in the late 2000s, the installation in 2006 and 2012 of two AN/TPY-2 surveillance and trajectory radars along the coast of Japan and then a THAAD battery and radar in South Korea, and – should Japan be involved in a conflict – with the additional support of Japanese missile defence systems and detection capabilities, this missile defence architecture is the most dense and complex in the world.

Responding to the challenge posed by these defences is a technically complex challenge for North Korea. In relation to short-range (500–800 km) ballistic missiles, interceptions are most often made in the atmosphere, either by low endo-atmospheric terminal defences (PAC-2, PAC-3, Cheolmae 2) around 15–30 km of altitude or by high endo-atmospheric area defences (THAAD) between 50 and 120 km of altitude. Short-range missiles cannot use traditional exo-atmospheric penetration aids to decoy the defences and can only rely on jammers to overcome them. The impossibility of using such penetration aids applies to missiles with a range of up to 1500 km, whose exo-atmospheric phase is too short to deploy them. Therefore, most of the North Korean non-strategic arsenal is exposed to missile defence, since missiles with an 800–1500 km range, which are the bulk of the strategic systems covering South Korea and Japan, are also exposed to exo-atmospheric interceptors (SM-3), THAAD and even to modernised terminal defences such as the PAC-3 MSE.

Although PAC-2/3 systems provide only point defence, their deployment serves to defend a number of sensitive military sites. In parallel, the deployment of SM-3 interceptors on US ships operating within the United States Pacific Command (PACOM) also defends the southern part of the Korean peninsula, especially the strategic region of Pusan. While defences are vulnerable to a saturation or defence-suppression strike, and to interceptor exhaustion, leaving a number of strike options open to North Korea, in a longer-term perspective the systems in place necessarily expose North Korea's short- and medium-range missiles to an increasing interception risk – a trend that is reinforced by South Korea's development of a national missile defence architecture (Korean Air and Missile Defence – KAMD) that complements that of the US.

It should also be noted that, during the 1990s and 2000s, US programmes under development, or even studies for potential programmes, may have influenced the choices made by North Korea, although there is no direct evidence. Among them, the Airborne Laser (ABL) programme<sup>67</sup> and the US studies on boost or ascent-phase<sup>68</sup> interception could have had a major impact, as these types of weapon systems

---

<sup>67</sup> The Airborne Laser (ABL) programme aimed to deploy high-powered lasers on heavy aircraft to perform laser intercepts during the boost phase of the missile. Two successful intercepts were made in the early 1990s before the programme was abandoned in 2011 owing to the immaturity of laser technology. Programmes to develop kinetic interceptors have also been envisaged since the 1990s, and these programmes continue to generate latent interest in the United States.

<sup>68</sup> See for example David K. Barton (et al.), Report of the American Physical Society Study Group on Boost-Phase Intercept Systems for National Missile Defense: Scientific and Technical Issues, *Reviews of Modern Physics*, vol. 76, n°3, 2004, and, more recently, National Research Council, *Making Sense of Ballistic Missile Defense: An Assessment of Concepts and*

pointed to the possibility of US deployment from airborne platforms that could intercept a missile in the initial phase of flight.<sup>69</sup> This category of interceptor, considered very seriously in US programming during the 1990s and 2000s, theoretically poses a particularly strong threat to ballistic missiles.

The rapid deployment of missile defence in the US forces has probably been a driving factor in North Korea's technological choices when defining its next generation of missiles. Indeed, with the KN-23 and KN-24, Pyongyang has opted for the development of quasi-ballistic missiles<sup>70</sup> rather than focusing, as China did, on ballistic missiles with manoeuvrable re-entry vehicles. Much more difficult to intercept than ballistic missiles and even manoeuvrable re-entry vehicles, quasi-ballistic missiles have primarily been developed by the United States (MGM-140 ATACMS) and the Soviet Union/Russia (SS-21 and SS-26) to evade missile defences, initially at the expense of accuracy. The KN-23 and the KN-24 are directly inspired by these two systems.

The importance of missile defence in Pyongyang's calculations can be discussed, since the choice of quasi-ballistic missiles as future short-range systems was probably made in the 1990s, a time when missile defence was nascent and deemed inefficient against opponents likely to use WMD. The issue of defences is often approached from an angle that can result in their potential impact being underestimated, with most assessments assuming that the probability of missile interception is high (in the order of 80 to 90%) but that defences are systematically susceptible to being faced with a massive attack using nuclear weapons.<sup>71</sup> A nuclear attack would require defences, in order to be considered functional, to intercept the vast majority of warheads or missiles, invariably leading to the argument that a considerable number of interceptors are required, leading to the conclusion that missile defence is unsustainable.<sup>72</sup>

However, such an assessment tends to present the issue of defences in strategic terms that are not necessarily appropriate to the case at hand. If we assume instead that North Korea would not be in a position to launch a massive ballistic attack and that, owing to operational constraints, the ballistic battle would consist instead of a series of successive limited engagements of missiles with conventional or chemical payloads, then the statistical assessment is quite different. For example, if we assume that the probability of individual interception is not 90% but only 50%, but that defences face relatively small

---

Systems for U.S. Boost-Phase Missile Defense in Comparison to Other Alternatives, Washington, DC: The National Academies, 2012, <https://www.nap.edu/catalog/13189/making-sense-of-ballistic-missile-defense-an-assessment-of-concepts>.

<sup>69</sup> The idea of deploying space-based or airborne interceptors has been periodically reevaluated in the US since 2016,

salvo attacks<sup>73</sup> and that the target areas are densely populated with defences – which is the case for now for almost all areas of military significance in the northern half of South Korea – then the effects are different. As the following graph shows, if the defences have the ability to assign four interceptors per incoming missile, a ten-missile salvo attack has a 60% chance of being completely intercepted by a single-layer defence system (i.e. one that does not have the ability to re-engage the target a second time). This single-layer architecture still represents South Korea’s existing response to short-range threats.

*Figure 10. Probability of intercepting a salvo attack based on the number of interceptors and the number of ballistic missiles*

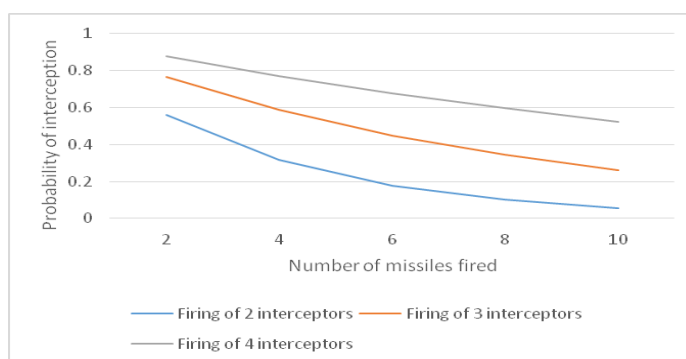

Engaging four interceptors per missile may seem unrealistic, as it would not only lead to rapid depletion of the interceptor stockpile but would also deprive the batteries of any reserve engagement capability absent reloading. Thus, in the event that North Korea is able to carry out large enough strikes, the role of defences would quickly become marginal. On the other hand, in the context of a limited strike, in which North Korean forces were only very partially mobilised, the defender could afford to significantly increase the number of interceptors per missile and thus significantly mitigate the effects of the strike, albeit at the cost of being unable to use those interceptors later in the war. As such, the arsenal tends to lose one of its primary functions, since its contribution as an element of crisis management is greatly reduced.

Since the first deployment of five US PAC-2 batteries in 1994, the role of missile defence in South Korea has been discussed at length. Seoul has been rather reluctant to buy US equipment, favouring a national solution, while Washington has been pushing for a comprehensive deployment combining low endo-atmospheric (PAC-2/PAC-3) and high endo/low exo-atmospheric interceptors (THAAD).<sup>74</sup> Although it took more than 17 years to deploy this layered defence<sup>75</sup> from the North Korean perspective, this

Since the first deployment of five US PAC-2 batteries in 1994, the role of missile defence in South Korea has been discussed at length. Seoul has been rather reluctant to buy US equipment, favouring a national solution, while Washington has been pushing for a comprehensive deployment combining low endo-atmospheric (PAC-2/PAC-3) and high endo/low exo-atmospheric interceptors (THAAD).<sup>74</sup> Although it took more than 17 years to deploy this layered defence<sup>75</sup> from the North Korean perspective, this

<sup>73</sup> Although supposing reduced salvo attacks may seem arbitrary, it may result from the difficulty linked to the organisation of a salvo launch with Scud missiles, but also from the inaccuracy of the missiles themselves. Trajectory data for non-maneuvring targets enables sensors to avoid engaging missiles that do not threaten a critical area – reducing the effective ratio between the total number of missiles launched against a target, the number of missiles to be engaged, the number of interceptors available and the number of interceptors allocated to intercept each missile.

<sup>74</sup> For instance, in 1999, the US Department of Defense stated ‘Using four upper tier endo-exo-atmospheric batteries (similar to the THAAD system) and seven lower tier batteries (similar to the PAC-3), all of the country beyond the immediate reach of very short-range ballistic missiles could be covered. Since most North Korean missiles attacking the ROK do not fly high enough for the exo-atmospheric upper-tier systems to engage them, the critical feature for the coverage achieved by this architecture is the minimum intercept altitude of the endo-exo-atmospheric upper-tier system’. Department of Defense, *Report to Congress on Theater Missile Defense Architecture Options in the Asia-Pacific Region*, 14 April 1999.

<sup>75</sup> Notably with the deployment of the first South Korean interceptors at the end of the first decade of the 2000s and the modernisation of the US missile defence architecture and its gradual evolution towards a multi-layered system, made concrete since 2017 with the deployment of THAAD.

development may have been long anticipated. The US rhetoric and the numerous programmes launched at the end of the 1980s and beginning of the 1990s, most notably for theatre defence, were obvious signs that these systems could be massively deployed in South Korea. Those include, for instance, the North Korea threat narrative used by Republicans to compel the Clinton administration to develop theatre and strategic defences, their pivotal role in the strategy of the Bush Jr. and Obama administrations, as well as the constant pressures of the United States to convince its allies to deploy it. This may explain North Korea's focus on quasi-ballistic systems, which offer the highest probability of penetrating defences.

However, even if missile defence may have been a driving factor in the modernisation of the North Korean arsenal and may explain some technical choices, the protean nature of the transformation of US and South Korean forces over the past twenty years obviously makes it difficult to analyse the objectives sought by North Korea in modernising its arsenal. It notably remains difficult to assess whether this modernisation was carried out with a view to a fundamental change in mission, in order to provide North Korea with an effective conventional strike capability and enable it to pursue limited operations, or to improve its overall conventional warfighting capability, or whether the transformation was ultimately initiated in order to guarantee the credibility of a deterrent based on the threat of WMD use

Modernisation must of course also be seen in the context of the emergence of nuclear capability, in both strategic and tactical terms. However, even if we assume that North Korea might want to develop a nuclear strike capability from the lowest tactical level up to the strategic level, the development of such a capability would result in the United States evolving its deterrence strategy in return. While the development of operational nuclear capability may strengthen the deterrent character of the North Korean arsenal, a corresponding change in the US strategy would probably limit the impact of this transformation and increase the risk of prompt reprisal in case of use. Therefore, despite the reinforcement of North Korea's capabilities through both missile modernisation and the coupling of missiles with tactical nuclear weapons, Pyongyang may not have any greater flexibility in the event of a major conflict. Although the development of the KN-23, KN-24 and KN-25 missiles will allow North Korea to significantly improve its strike capabilities in both conventional and non-conventional terms, this modernisation will not necessarily allow Pyongyang to change its current deterrence model and move away from its heavy reliance on WMD.

The perspective changes, however, if we examine the contribution of modernisation to escalation management in the context of the coercive strategy of limited conventional strikes, carried out under cover of operational nuclear capability, since the accuracy of the missiles currently in development and their potential defence penetration capability open up a number of new options that are likely to increase South Korea's vulnerabilities, despite the adaptation of its armed forces, the evolution of its doctrines and the increasing support of the United States. On the assumption that the currently deployed defences are less able to intercept quasi-ballistic systems, North Korea could have sufficiently accurate strike capabilities to carry out selective strikes against economic or military facilities with high symbolic significance or industrial value. Conventional strikes on specific economic or military infrastructures, such as electrical substations and their relays for instance, represent a relatively low-risk strategy but can potentially be politically rewarding, especially if there is no direct human cost.

At a higher level of risk, strikes on critical industrial infrastructure targets, which would likely come with greater human losses, are another option that could be chosen by Pyongyang, especially targeting sites where South Korean industry plays a key international role (such as the production of semiconductors, telephones and integrated circuits). This economic deterrence capability is currently unique, as no other major industrial power – with the exception of Taiwan – is exposed to short-range strike systems capable



of durably affecting entire sectors of the national and the international economy with a relatively limited number of weapons. In parallel, again assuming defence penetration capability, focusing strikes on symbolic military targets (such as early warning radars) or targets directly associated with an incident of a military nature (air base, or artillery unit) represents a means of controlled escalation widely used by great powers and thus perceived as 'acceptable'.

It is important to note that, at present, North Korea is not yet in position to move towards conventional strike strategies in the event of a major conflict, since its stockpile of sufficiently accurate weapons is and will remain, at least in the medium term, too small for such strikes alone to generate sufficient military effect to hamper the South Korean or US war effort. Conversely, the effect will be more tangible if conventional strikes ease the use of WMD, and particularly chemical weapons, by neutralising defences but also by having destructive effects on areas previously protected from chemical strikes. Thus, the emerging conventional deep strike capability creates increased uncertainties linked to the characteristics of new short-range missiles in development. In the following parts of the report, by attempting to estimate what the characteristics of North Korea's new generation of missiles might be and by outlining some possible scenarios for their use, we offer some speculations on how North Korea's strike strategy might develop.

### 3 The transformation of the arsenal

---

North Korea's short-range arsenal is being transformed in two main ways: first, through the development of solid propellant manufacturing capability; and second, through the development of expertise in the various technologies involved in quasi-ballistic missiles.

#### 3.1 The development of solid propellant production capability

The development of industrial infrastructure to produce composite solid propellants likely began in the 1990s with the acquisition of the SS-21 from Syria.<sup>76</sup> Since Syria is not thought to have any autonomous production capability for solid propellant, North Korea must have drawn on other sources to acquire skills and industrial capacity, which have not yet been fully identified. It is highly likely that Pyongyang built its initial production capability for composite propellants around the SS-21's propellant (DAP-15V) for production of the KN-02. The production sector may subsequently have been updated and could serve as a basis for the systems currently under development.

As such, although the expertise in solid propellant acquired to date by North Korea for medium- and large-diameter missiles<sup>77</sup> has been surprising, the emergence of the industrial infrastructure is not inexplicable, having taken place over a period of thirty years or so. It has enabled Pyongyang to gradually master production of the basic components<sup>78</sup> and to acquire the industrial equipment necessary to produce blocks of propellant of medium diameter (more than 800 mm) and large diameter (more than 1.4 m, requiring very high-quality production processes). Although much of this remains rather obscure – particularly as regards the production or acquisition of binders – initial production capability was identified at the end of the 1990s. In 1998, a source identified the Hungnam Fertiliser Complex as a production site for ammonium perchlorate, and claimed that the bulk of its output was sent to the No. 17 Explosives Factory,<sup>79</sup> where the first solid propellants were produced. The output was probably destined for the future KN-02. However, the production of blocks of propellant for missiles of larger diameter required modernisation of the infrastructure, which can be seen clearly on satellite images taken of the No. 17 Explosives Factory in 2012, suggesting that research to this end began in the late 1990s or early 2000s.

Two production zones have now been identified. The first is probably dedicated to the production of blocks of propellant for large-diameter missiles (1.4 m plus, south area of the site). It was constructed

---

<sup>76</sup> Joseph S. Bermudez Jr., 'The KN-02 SRBM,' *KPA Journal*, vol.1, n°2, February 2010. The author notes that North Korea built up its initial production capability for double-base (glycerine trinitrate) solid propellants for its Frog 5 and Frog 7 heavy rockets. See also Joseph S. Bermudez Jr., *A History of Ballistic Missile Development in the DPRK*, Center for Non-proliferation Studies, Occasional Paper no. 2, Monterey Institute of International Studies, 2010.

<sup>77</sup> Propellant loads of medium diameter are defined as those between 800 and 1400mm, and those of large diameter greater than 1400 mm.

<sup>78</sup> For composite propellants, these are ammonium perchlorate, aluminium powder or other metallic powder, liner and binder; and for the structural elements and nozzles they consist of composite materials such as fibreglass and carbon fibre.

<sup>79</sup> Yi Chae-sung, *Pukhanul Umjiginun Tekunokuratu* [in Korean], Seoul, 1998, 123–174, cited by Joseph S. Bermudez Jr in 'North Korea's Solid-Propellant Rocket Engine Production Infrastructure: The No. 17 Factory in Hamhung,' *38th North*, 30 January 2018, [https://www.38north.org/2018/01/no17factory180130/#\\_ftn5](https://www.38north.org/2018/01/no17factory180130/#_ftn5).

recently (2012–14). According to Joseph Bermudez,<sup>80</sup> a second, older site can be identified in the north of the complex, which is probably involved in the production of propellants for the KN-02. The site was modernised in 2011–12, possibly in connection with the production of medium-diameter blocks of propellant for the KN-23, KN-24 or KN-25 missiles, for example.<sup>81</sup>

*Figure 11. Possible production zone for propellant for the KN-02, reconstruction (October 2012) and current state of the infrastructure, possibly for the KN-23 and KN-24,<sup>82</sup> north zone.*



*Figure 12. Foundations of the production zone, October 2012, and completion of the building, December 2014, south zone<sup>83</sup>*



<sup>80</sup> Joseph Bermudez Jr., 'North Korea's Solid-Propellant Rocket Engine Production Infrastructure.'

<sup>81</sup> Other than the production sites in the Hungnam region, no other production site for solid propellant has been publicly identified. To the north of the No. 17 Factory, the February 8 complex is also suspected of playing some role in the production of liquid or solid propellants. See for example Joshua H. Pollack, Miles Pomper, Ferenc Dalnoki-Veress, Joy Nasr, and Dave Schmerler, *Options for a Verifiable Freeze on North Korea's Missile Programs*, CNS Occasional Paper n°46, April 2019, [https://nonproliferation.org/wp-content/uploads/2019/04/options\\_for\\_a\\_verifiable\\_freeze.pdf](https://nonproliferation.org/wp-content/uploads/2019/04/options_for_a_verifiable_freeze.pdf).

<sup>82</sup> Joseph Bermudez Jr., 'North Korea's Solid-Propellant Rocket Engine Production Infrastructure,' op. cit.

<sup>83</sup> Panel of Experts established pursuant to resolution 1874 (2009), S/2020/151. All references given hereafter to documents from the Panel of Experts are identified by their code.

North Korean industrial capabilities do not yet appear to be suited to the production of large-diameter blocks of propellant. Problems in the production of sufficiently fine propellant grains and the elimination of impurities may have been encountered.<sup>84</sup> Large-diameter missile tests indicate a certain expertise, but the energetic quality of the propellant may be low. Tests of large diameter missiles such as KN-11/KN-15/KN-26 displayed relatively short ranges. The last version tested (KN-26/Pukguksong-3), a two-stage missile of 1.4 m in diameter, appears to have achieved a theoretical range of 1700–2500 km (as deduced from the test on 2 October 2019), which is relatively low for a missile of this type.

Conversely, the tests carried out with the KN-23, KN-24 and KN-25 missiles, which are all medium-diameter devices (around 600 mm to 1 m), seem to suggest the use of good quality energetic propellant. In the case of the KN-23, which the Panel's documentation describes as being almost identical to the Russian missile SS-26E Iskander (in overall mass, length and diameter), longer ranges have been shown in the tests than for the SS-26E, closer to the (estimated) ranges of the SS-26M version<sup>85</sup> deployed by Russian forces and presumably not exported. This raises the question of the origin of the propellant.

It is difficult to provide a definitive comparison of the KN-23 and the SS-26E in the absence of precise data, as the respective structural indices<sup>86</sup> of the two missiles and the exact payload of the North Korean missiles are unknown. Furthermore, inferring the nature of the propellant solely from the respective ranges of the SS-26 and the KN-23 is problematic, since the precise trajectories of the two missiles cannot be compared. Nonetheless, the performance of the KN-23 is close to that of the SS-26M. It could therefore be supposed that the two missiles use nearly identical propellants. But this hypothesis would imply the transfer of production capabilities from Russia to North Korea, which seems unlikely, although transfer of propellant technology and know-how is a credible possibility. Alternatively, we might hypothesise that North Korea is capable of producing a propellant with energetic qualities very similar to those of the propellant used in the SS-26, which would be surprising since North Korean engineers have very limited experience of modern solid propellants – but more credible assuming technology transfer from entities in China or Russia. Finally, as demonstrated in the following part of this study, we must also consider the possibility that the dimensions of the North Korean missile are greater than those of the Russian missile. In this case, a plausible hypothesis, albeit not one that can be confirmed by any open sources, would be that the missiles are fuelled by a derivative of the DAP-15V propellant used in the SS-21/KN-02. Carrying a larger propellant mass than the SS-26, the KN-23 could then achieve greater ranges than the SS-26E without this implying the transfer of production capacity for the SS-26 propellant or advances in North Korean technology and technical capability.

It should be noted that a KN-02 missile test carried out in 2014 at a range of 220 km (as opposed to 120–160 km for the operational version) was followed by a significant firing campaign, suggesting the

---

<sup>84</sup> 'Other procurement choke-points items included solid propellant. A typical composite formula involved aluminium powder and ammonium perchlorate. Although the DPRK had manufacturing capacity, DPRK plant might not be operating well according to a Member State. It was assessed that the DPRK had difficulty in producing such materials at the right degree of purity and particulate size,' S/2020/151.

<sup>85</sup> It has been suggested that the range of the SS-26M is around 700 km, depending on payload. See for example Stefen Fross, *The Russian Operational-Tactical Iskander Missile System*, Working Paper n°42, National Defense University (Finland), 2012.

<sup>86</sup> I.e. the mass of the propulsion stage in relation to the propellant mass.

existence of development work on DAP-15V propellant or even the development of a more advanced propellant.<sup>87</sup>

*Figure 13. Test of a variant of the KN-02, August 14, 2014.<sup>88</sup>*

Whatever the case may be, the example of the KN-02 seems to show that North Korea has achieved genuine expertise in the production of medium-sized blocks of propellant, which it has been able to transfer to KN-23 missiles, but also to the KN-24s and KN-25s. Furthermore, barring choke points in production (possibly in the production of liners, crosslinking agents and binders, and of military-grade aluminium particles), North Korea is able to envisage a gradual reshaping of its strike system around solid-fuel systems.



*Credits: KCNA*

The development of North Korea's industrial capabilities is also notable in the domain of motor cases and rocket nozzles, with steel and steel alloy structures gradually abandoned in favour of lighter composite materials. In its 2020 report, the Panel of Experts emphasised that carbon-carbon composites do not seem to be produced in North Korea, which forces the country to use less suitable composite materials (particularly Kevlar-type materials) for certain sensitive parts (such as nozzles). North Korea has made notable progress, however, to the point of being able to replace metallic structures, particularly on motor cases, as shown in images of the Pukguksong-2 and 4.<sup>89</sup>

*Figure 14. Composite material structure on the propulsive section of the Pukguksong-2.*

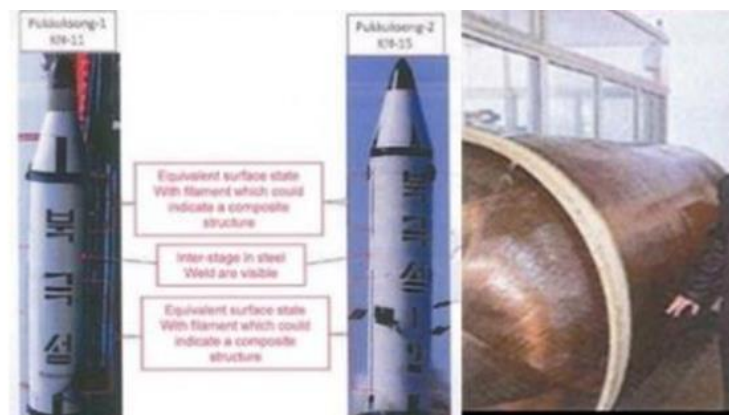

*Credits: KCNA and S/2019/171*

<sup>87</sup> On the Soviet version of the SS-21 (9K79-1), the modification of the propellant carried out during the 1980s enabled a notable increase in the performance of the missile, whose range increased from 70 km to 120 km, reportedly with the same payload.

<sup>88</sup> S/2015/131, Final report of the Panel of Experts submitted pursuant to resolution 2141 (2014), United Nations Security Council, 23 February 2015, <https://www.undocs.org/S/2015/131>.

<sup>89</sup> S/2019/171 and S/2021/2011.

Nevertheless, production capacity clearly remains a particularly constraining factor on the development of the arsenal. According to one of the member states of the Panel of Experts, in total, the tests that have been carried out with solid-fuel devices would have required around 100 tonnes of solid propellant over ten years, a figure that does not allow us to deduce the stock level or production capacity.<sup>90</sup> As it stands, the main identified production site for ammonium perchlorate is located at the Hungnam Fertiliser Complex. Certain reports by occasional visitors to the plant seem to suggest that the site has not been functioning at full capacity in recent years.<sup>91</sup> The recent opening of a fertiliser factory at Sunchon has not as yet been connected to any production of perchlorate. It is also possible that North Korea has encountered problems in the production of the high-quality aluminium powder necessary for its production of large-diameter blocks of propellant, and possibly also for medium-diameter blocks. As it stands, open sources do not provide sufficient information to assess national production capacity, even with a large margin of error.

One of the elements most likely to slow down modernisation of the arsenal in the short term is the development of medium- and intermediate-range strike capability around the solid-propellant Pukguksong systems, the ground-based version of which is likely intended to gradually replace the Nodong and Musudan systems. Although the number of missiles expected to enter into service may be small, particularly if Pyongyang plans to combine them only with nuclear weapons, this programme is most probably a priority since it allows Pyongyang to pose a more credible threat against the US missile bases in the region, but also against Japan, and thus represents a prime element for North Korean deterrence.

Paradoxically, the development of tactical systems, and particularly of the heavy guided rockets KN-25 and possibly the KN-09, may also have a negative impact on the modernisation of the rest of the short-range arsenal. The characteristics of the KN-25 (see Parts 4.3 and 4.3.2) may suggest that the same propellants are used for this system and for the KN-23 and KN-24. As the KN-25 is similar to a heavy artillery rocket, its use may be linked to massive strikes against multiple targets, which could then lead to a higher demand for propellant production, particularly as the missile carries a heavy load of propellant, estimated at 2400 kg. The development of new types of solid-propellant missiles (a new SRBM was displayed to the public on April 2022 and a new large-diameter SLBM in 2021) may worsen this trend.

The capacity of North Korean industry to meet the demands of the armed forces and the priorities they dictate are therefore criteria that must be taken into consideration. Although no information is available on this subject, the possibility that North Korea finds itself facing constrained choices in relation to production, with an impact on the volume of available weapons, cannot be excluded. Finally, there remains the question of the ageing of the propellants produced,<sup>92</sup> the effect of which cannot be evaluated, but may also exert pressure on stock, especially if accelerated ageing sets in after a few years.

---

<sup>90</sup> S/2020/151.

<sup>91</sup> In the particular case of the production of ammonium perchlorate, North Korea may draw on external sources: the US administration, for example, has issued an advisory on the importing of sodium perchlorate, used in the production of ammonium perchlorate from ammonium salts. See 'North Korea Ballistic Missile Procurement Advisory,' US Department of State, Department of the Treasury, Department of Commerce, 2021.

<sup>92</sup> Solid propellants are generally made to last for the whole duration of the life of the missile. Replacing blocks of propellant is difficult and is unlikely to be within North Korea's capability. The aging of solid propellant, which is closely linked to the process of fabrication, is therefore an important question, particularly for states that plan to build up a significant stock.

Because of these various parameters, caution should be exercised in any extrapolation of North Korea's potential strike capability, since the quantity and quality of weapons available depends on propellant production infrastructure that, as things stand, seems inadequate to meet demand. A similar analysis is required in relation to critical components, particularly those used in navigation and guidance systems, a number of which are probably imported, and on final assembly capability for overall missile systems. Given the lack of data, this question is not explored further here.

### 3.2 The choice of quasi-ballistic systems, and questions raised by the KN-23 and KN-24 tests

One of the biggest surprises about the development of the KN-23 and KN-24 missiles is of course the ability of these systems to achieve quasi-ballistic trajectories. The KN-25 follows a very depressed ballistic trajectory, with the missile remaining in the atmosphere. The development of this capability poses a number of questions. Although the history of the KN-23 and KN-24 programmes is not clearly understood, the development of this type of system and the infrastructure required, from expression of need to completion of the test phase, would generally take around fifteen to twenty years. Officially, 'non-strategic guided missiles' – which in North Korean terminology means the KN-23 and KN-24 missiles – have been a top priority since finalisation of the development of the strategic programmes, i.e. since 2016. The development of this category of missile was officially mentioned during the 7<sup>th</sup> North Korean Communist Party Congress in May 2016,<sup>93</sup> along with new means of artillery strikes, i.e. the KN-09 and KN-25 systems. This decision, prior to the test flight phase, may explain the intensity of the tests and may suggest an accelerated deployment in the armed forces in a short timeframe.

It seems likely that Pyongyang settled on the choice of a quasi-ballistic missile between the end of the 1990s and the mid-2000s. The method of proliferation to develop this technology is probably different than the one experimented for the Scud B. It is widely assumed that it was developed through the retro-engineering of SS-1c missiles acquired from Egypt. The possibility that North Korea imported production capacity for SS-1c missiles while building up capacity for manufacturing Scud B and C missiles has also been regularly suggested by some researchers to explain the extremely close similarities between North Korea's Scud B and the Soviet SS-1c,<sup>94</sup> as well as the small number of tests carried out and North Korea's capacity to design and produce the missile in a short space of time.

In the case of the KN-23, the missile is probably not an almost exact replica of the Russian SS-26 but a derivative, whereas the KN-24, which has the same generic form as the US MGM-140 ATACMS guided rocket, is in fact a different system. Ruling out the hypothesis of direct transfer of SS-26 technology and industrial capacity, North Korea must have proceeded by way of reverse-engineering, probably on the basis of relatively precise technical data for the KN-23, which shares a number of technical solutions employed in the SS-26, and on the basis of more diffuse sources for the KN-24, for example from

---

<sup>93</sup> Seung Ki Shin (신승기), 'Analysis of North Korea's Guided Weapon Development Process and Future Prospects [북한의 유도무기 개발 과정 분석과 향후 전망]', *Korea Institute for Defense Analysis (KIDA)*, Northeast Asia Strategic Analysis, 27 January 2021.

<sup>94</sup> This is the argument put forward by Markus Schiller and Robert Schmucker. See for example Robert Schmucker, '3rd World Missile Development—A New Assessment Based on UNSCOM Field Experience and Data Evaluation,' 12th Multinational Conference on Theater Missile Defense, Responding to an Escalating Threat, Edinburgh, 1–4 June 1999.

information gathered in Iraq where the MGM-140 was widely used. The design period of the two weapons was therefore probably long, especially since it had to be ran in parallel with the construction of production facilities. By comparison, certain analyses suggest that the design of South Korea's Hyunmoo 2B, also visually similar to the SS-26, was facilitated by contact between South Korea and Russia in the early 1990s,<sup>95</sup> as the programme was completed during the 2000s. The potential interval between the design studies carried out in South Korea and final completion of the weapons system would thus have been around twenty years, knowing that Seoul has an industrial and technological base greatly superior to that of North Korea, and is perfectly capable of producing missile components nationally or by purchasing licences. It would therefore not be surprising that the development of the KN-23 had taken more than two decades.

Assuming that the specifications for the KN-23 were defined somewhere between the end of the 1990s and the middle of the 2000s, numerous questions arise. While a logical hypothesis might be that North Korean military leaders wanted to develop missiles that were more precise than the Scud B and C, the decision to develop quasi-ballistic systems, however, suggests that the development of missile defences was the deciding factor, and prevailed over the question of accuracy.

For if accuracy alone had been the objective, then developing manoeuvrable re-entry vehicles would in theory have been a simpler option. Following a ballistic trajectory, a manoeuvrable re-entry vehicle makes corrections in the trajectory in the final flight phase, during re-entry into the atmosphere. Combined with a sufficiently high-performance terminal guidance system, this kind of warhead offers a high degree of accuracy, with even the least sophisticated guidance systems enabling a reduction of circular error probable (CEP) to well below 100 m, and the most complex bringing it down to between 10 and 50 m. Since the majority of the trajectory remains ballistic, it does not have to be coupled with a global navigation satellite system (GNSS) signal after the boost phase in order to ensure accurate navigation, thus limiting the missile's exposure to jamming.

Quasi-ballistic missiles are distinguished from manoeuvrable re-entry vehicles by their trajectory, which remains entirely within the atmosphere. They can also achieve greater accuracy, since they can be guided through long portions of their trajectory, but are more dependent on a GNSS signal to correct any drift during navigation. Although little data is available from open sources, early quasi ballistic missiles or heavy guided rockets, whose range was short (165 km for the first version of the MGM-140 and 70 km for the SS-21) and whose navigation was entirely reliant on inertial guidance, attained low to moderate accuracy. The CEP of the SS-21 is usually estimated at between 150 and 200 m. The accuracy of the first version of the US MGM-140 heavy rocket is unknown, but we may reasonably estimate it to be between 100 and 150 m at maximum range.<sup>96</sup>

Although the integration of GNSS into the navigation of quasi-ballistic missiles guarantees greater navigational accuracy and can act as a terminal guidance system, North Korean military chiefs did not necessarily opt for quasi-ballistic systems in pursuit of accuracy. During the 1990s or early 2000s when the programmes were launched, North Korea did not have the technical and financial capacity to deploy a satellite constellation capable of guaranteeing it an independent GNSS signal and could not expect to have one. Although the *possibility* of hybridising the inertial guidance with a GNSS signal may have been

---

<sup>95</sup> Daniel Pinkston, 'The New South Korean Missile Guidelines and Future Prospects for Regional Stability,' *International Crisis Group*, 25 October 2012, <https://www.crisisgroup.org/asia/north-east-asia/korean-peninsula/new-south-korean-missile-guidelines-and-future-prospects-regional-stability>.

<sup>96</sup> We note that the Russian site [Missilery.info](https://en.missilery.info) estimates the CEP at 300 m. See <https://en.missilery.info/missile/atacms>.



considered as a workable option, particularly from the perspective of the deployment of Russian and Chinese constellations, the vulnerability of this type of navigation to jamming was already evident in the 1990s, ruling out defining the navigation and guidance characteristics of weapons systems solely with GNSS, in particular with a commercial signal. At this time, it was still hardly conceivable to compensate the reliance on the US GPS by combining multiple commercial signals (from future Chinese, Russian, and European constellations) for military use. Unless they were willing to accept a reliance on China or Russia to furnish a military-grade signal (more difficult to jam), which is highly doubtful, it seems unlikely that North Korean leaders would have originally considered the development of quasi-ballistic missiles for precision strikes.

In this context, the emergence of the first manoeuvrable re-entry vehicles in Iran in 2015 (the Emad, a derivative of the Shahab-3, then the Qiam-2, a derivative of the Shahab-2/Scud C) demonstrates that proliferating states were capable of developing these technologies in the 2000s. Technology exchanges with North Korea cannot be excluded, since the KN-18 (a Scud B fitted with a manoeuvring warhead) and the KN-21 (a Scud C fitted with a manoeuvring warhead) are rather similar to Iran's Qiam-2.<sup>97</sup> North Korea could also have been inspired by Chinese programmes, particularly the DF-15 programme, or by the old Russian Aeroфон program.<sup>98</sup> With access to these foreign technologies and possessing enough technical and industrial capacities, Pyongyang might then have favoured the development of manoeuvrable re-entry vehicles that would have allowed it to fully exploit its existing industrial potential by using converted Scud boosters.

Manoeuvrable re-entry vehicles are, however, exposed to the risk of exo-atmospheric interception over long ranges as well as, for shorter-range systems, THAAD-type interceptors, which are capable of reaching them before their upper atmosphere manoeuvres can begin. They are also vulnerable to lower endo-atmospheric systems such as PAC-3s, although interception is very difficult. Manoeuvrable missiles thus represent a solution more suited to precision strikes than to defence penetration.

The major investment North Korea must have committed to build the production infrastructure for solid propellant missiles but also for the conception of modern quasi-ballistic systems from scratch, and the limits placed upon such systems by the dependence on GNSS for accurate navigation, thus suggest that defence penetration was probably Pyongyang's principal objective. From this point of view, the emphasis that has been placed on accuracy in North Korean propaganda for some years seems a notable development, which may reflect a desire to impress the United States and South Korea with a demonstration of capability, but also to indicate that precision strikes are now an operational option. In this context, some analysts suggest that since 2014, particular efforts have been made to acquire components linked to navigation and guidance, which may illustrate a reorientation of priorities from systems primarily designed to overcome defences to systems able to strike with high precision.<sup>99</sup>

---

<sup>97</sup> There are however significant differences between the Qiam-2 and the KN-21. The Qiam-2, which combines a manoeuvring head with a Scud C-type launcher, for example, is based on a modified version of the Scud C and may be more accurately guided during the boost phase than the traditional Scud C used on the KN-21. The comparative characteristics of the Qiam-2's manoeuvring warhead and that of the KN-18 or the KN-21 cannot be evaluated.

<sup>98</sup> The Aeroфон was prototype of a manoeuvrable re-entry vehicle developed by USSR for the Scud in the 1970s. It has long been supposed that Iran or North Korea may have had access to this technology, but it has never been attested.

<sup>99</sup> Seung Ki Shin (신승기), 'Trends and Changes in North Korea's Defense Science and Technology Policy after Kim Jong-un Took Office' (김정은 집권 이후 북한 국방과학기술정책의 추진 동향과 변화 양상), *Korea Institute for Defense Analysis (KIDA)*, ROK Angle, November 2020. See also Mansourov, *Kim Jong Un's Nuclear Doctrine and Strategy*.

The emphasis on precision by the North Korean authorities in recent times, demonstrated by several test flights, raises questions about how the accuracy of the missiles is ensured, and more precisely the role played by GNSS in the navigation and guidance of North Korean missiles. It is possible that the inertial navigation of the missiles – the KN-25 included – is hybridised with a GNSS receiver. An advisory issued by the US administration mentions, among other things, the risk of North Korea acquiring NV08C-CSMS multi-constellation GPS receivers, lending weight to the idea of the presence of a GNSS receiver. The advisory also warns of the acquisition of fibre-optic, laser or MEMS gyroscopes, which represent the most recent and up-to-date generations of gyroscope technology, probably reflecting North Korea's ambition to acquire minimal autonomy in respect to these components, which are important for all their ballistic programs but essential for any high precision quasi-ballistic programme. From this point of view, it is interesting to observe that the US administration also issued an advisory on the acquisition of the QA-2000 accelerometer,<sup>100</sup> described by its manufacturer as the accelerometer most commonly used by second-generation (strapdown) inertial navigation systems. This advisory may suggest that strapdown inertial navigation systems represent the current state of the art in North Korea, and that the navigation systems of most of the missiles recently produced by the country are reliant on this technology. This type of navigation system is, however, insufficient by itself to ensure precise navigation for the flight of long-range quasi-ballistic missiles such as the KN-23, notably if some manoeuvres are realised during the flight. It is therefore possible that North Korea has more modern imported technologies or, that it is forced to rely extensively on GNSS to ensure the precision navigation of the KN-23 and KN-24 devices. Since the KN-25 follows a ballistic trajectory, strapdown navigation systems are possibly sufficient for its navigation, even if the low trajectories measured during some flight tests may suggest that the rocket may be guided during some of its flight path, possibly with a GNSS. As with GNSS, the existence of terminal guidance systems, optical or radar, on the KN-23, KN-24 and KN-25 has not been identified. The dimensions of the two missiles would enable this type of sensor to be integrated without difficulty, and North Korea may have access to such technologies via the intermediary of Iran, which has mastered the integration of electro-optical and passive sensors, or its traditional Chinese- or Russian-entity suppliers.

Assuming that the guidance of the KN-23, KN-24, and KN-25 is dependent on a GNSS signal to ensure optimal precision, but that North Korea does not have access to a military-grade signal that can be used in a hostile environment, in what configuration might they be used? When fired from deep within national territory, coupling between the missile's inertial navigation and the GNSS signal remains possible in the initial flight phase, with a low risk of exposure to jamming. As the trajectory continues, depending on the distribution of antennae on the missile, loss of signal due to jamming may be delayed. The use of pseudolites or LPS (Local Positioning Systems) may also offer recourse to a complementary signal, but would mean that these devices would have to be deployed in South Korea. Based on the expected technologies in future inertial navigation systems with greater precision than the strapdown systems possibly in use at present, a realignment by GNSS signal during the initial flight phase or part of the flight, and then continuation of the flight under inertial navigation guidance alone, could make it possible to limit any drift, with the missile then activating a terminal sensor to guide it to the target.<sup>101</sup>

One of the interesting features of the KN-23 and KN-24 test flights concerns the atmospheric skipping manoeuvre performed during the non-powered phase of the flight. Such a skip can serve multiple

---

<sup>100</sup> See 'North Korea Ballistic Missile Procurement Advisory.'

<sup>101</sup> For a description of GNSS guidance, see George T. Schmidt, 'Navigation Sensors and Systems in GNSS Degraded and Denied Environments,' STO-EN-SET-197, *Science and Technology Organization*, NATO, 2013.

purposes, which vary depending on the type of missile used, the speed at which the operation takes place and its objective:

- ❖ For a ballistic missile with a manoeuvrable re-entry vehicle, after the warhead re-enters the atmosphere, a pull-up manoeuvre can be carried out in the dense layers of the atmosphere (at an altitude of around 15 km) in order to slightly lengthen the range (the exact range depending on the speed and the trajectory of the warhead), change the direction of the warhead and, when the latter has terminal sensors, increase the accuracy. This pull-up manoeuvre can only be carried out by a missile with a separable warhead. In order to extend the range significantly, the warhead may also be bounced off on the dense layer of the atmosphere.<sup>102</sup>
- ❖ A quasi-ballistic missile can also make a skipping manoeuvre to extend its range and change the direction of its trajectory. After the skipping manoeuvre, the quasi-ballistic missile will fly in the dense part of the atmosphere, where it can further manoeuvre. If it is coupled with terminal sensors, its accuracy can be greatly increased. Because the whole trajectory remains within the atmosphere, a quasi-ballistic missile is, in theory, able to modify its altitude on most of its trajectory through the use of aerodynamic control surfaces. Its trajectory is then even less predictable than the one of a manoeuvrable re-entry vehicle, which manoeuvres on a shorter distance during the terminal phase of its trajectory. Moreover, since the defender cannot know if the missile will skip or not, the interception can be rather complex. However, the changes in direction that can result from the skipping manoeuvre, along with any prior changes of attitude, have a decelerative effect on the missile. The advantage gained by such manoeuvring comes at the cost of a loss of speed, which may increase exposure of the missile to terminal defences.
- ❖ In the absence of any concern about defences, the extension of range can be maximal, and use of evasive manoeuvres greatly limited. Conversely, when confronted with defences, the missile must be able to carry out manoeuvres to elude them while retaining sufficient speed to reduce its exposure to interception during its terminal phase of flight. It is generally assumed that the operational trajectories and ranges should be defined in such a way that the terminal speed remains highly supersonic (approximately 0.9 km/s and above). In a context where a missile should overcome dense defences, range extension could be little to none and the operational range may be even significantly less than the nominal purely ballistic range.
- ❖ Depending on the characteristics of any terminal guidance sensors, the missile may also be forced to slow down during the terminal flight phase so that the sensors can lock onto the target. Similarly, the terminal speed must be low enough for any submunitions to be homogeneously distributed.
- ❖ The skipping manoeuvre is optional. A flight without skipping manoeuvre may be preferred for defence penetration, so that the missile retains enough energy to carry out manoeuvres during its trajectory and in the terminal phase.

In technological terms, the choices made by North Korea represent a considerable challenge for a state which, with the acquisition of Soviet and Syrian SS-21s, has only limited experience with quasi-ballistic technologies drawing on a missile that offers limited scope for further development. While it is probable that the inertial navigation systems (gyroscope and accelerator), computer, commands for the actuator and (laser) terminal altimeter system of the SS-21 were all reverse-engineered, and that its various subsystems may have been used in the KN-23, KN-24, and KN-25, the very design of the KN-23 illustrates

---

<sup>102</sup> For a good description of this kind of manoeuvre and the range and the speed of the warhead, see Ralph Savelsberg, *The DF-21D antiship ballistic missile*, AIAA Modeling and Simulation Technologies (MST) Conference, Boston (MA), 19–22 August 2013.

the strong influence of the SS-26, suggesting that similar solutions and perhaps similar subcomponents were used for the navigation and guidance systems of the North Korean missiles.

Taking into account the technological level reached by North Korea in the 2000s, these various assessments reveal two realities: first, North Korean engineers became aware very early of the problems linked to the interception of a short-range ballistic missile (SRBM) and, in order to overcome these problems, opted for rather ambitious solutions. By demonstrating the combination of a quasi-ballistic flight and a skipping manoeuvre, the KN-23 and KN-24 tests seem to show that defence penetration was probably the most important factor when defining the specifications of the missiles, since this technology was already known as the best one to overcome missile defences but was, at the end of the 1990s and the beginning of the 2000s, still challenged in terms of high precision. Second, putting in place the industrial infrastructure needed to develop these weapons required considerable investment, particularly for a state with no experience in this area. Finally, the relatively low number of failures identified in both the KN-23 and KN-24 tests seems to show that Pyongyang has been able to secure a number of technology transfers of complete systems or subsystems and has non-negligible expertise in terms of simulation, as well as the aspects of propulsion and aerodynamics.

## 4 The newly developed systems: KN-23, KN-24 and KN-25

---

These three missiles are all solid-fuel weapons with non-separating warheads. There are two distinct versions of the KN-23, with the second, heavier model having a greater range and payload than the first. No official name has been given to the heavier version; below we will refer to the first version as KN-23 and the second as KN-23A. In the analysis by the United Nations (UN) Panel of Experts,<sup>103</sup> the dimensions of the KN-23 seem to have been largely extrapolated from those of the SS-26E missile (the export version of the SS-26 with a 300 km range and 480 kg payload), shown below (Figure 14) for the purposes of comparison with the KN-23.<sup>104</sup>

Due to visual similarities, the KN-24 was initially compared with the MGM-140 (ATACMS) heavy guided rocket but its dimensions do, however, differ. The MGM-140 Block 1A is, however, used as a reference in the subsequent assessment,<sup>105</sup> having quite obviously inspired it.

Finally, the KN-25 is a heavy guided rocket relatively similar in design to most medium-diameter heavy rockets, such as those used by the Russians and the Chinese, although these are of smaller diameter (around 300 to 400 mm). It is, however, different from weapons in the 600 mm range produced in Iran and China, whose designs are different.

### 4.1 The KN-23 and KN-23A

#### 4.1.1 The KN-23

Observations of the most recent KN-23 tests allow us to posit a number of hypotheses concerning the architecture of the missile, its capabilities, potential uses and modes of deployment.

As far as its structure is concerned, the UN data describe the KN-23 as a clone of the SS-26E (with a similar diameter, length and propellant mass). The two missiles are undeniably very similar in their design, proportions and general aerodynamic characteristics. A number of other details are also comparable, in particular the components used for attitude control (control fins and jet deflectors) and launch procedure.<sup>106</sup> Finally, the TELs used also seem very similar.

---

<sup>103</sup> S/2020/151.

<sup>104</sup> Use of the SS-26E as a reference is somewhat arbitrary, and is due to the fact that this version is better known than the SS-26M, the version deployed by the Russian army but not officially exported. The KN-23's payload is defined at around 500 kg, in reference to the SS-26E's payload of 480 kg, while that of the SS-26M can be as high as 700 kg. In addition, comparison between the two missiles is misleading since the SS-26E is deliberately limited to 480 kg payload and 300 km range so as to respect the Missile Technology Control Regime (MTCR) Category I ceiling, whereas the demonstrated range of the SS-26M is reputed not to surpass 500 km, so as not to violate the Intermediate-Range Nuclear Forces (INF) treaty. In fact, it has been supposed that the potential range of the SS-26M may be around 700 km with a reduced payload. On this particular aspect, see Stefen Fross, *op. cit.*

<sup>105</sup> As in the case of the SS-26, using the MGM-140 as a reference is somewhat inaccurate, since the range of the US guided rocket depends on the payload (165 km for the original version, with a payload of around 600 kg, and 300 km for the later deployed versions, with a payload of around 150 to 200 kg).

<sup>106</sup> Markus Schiller, Twitter, 5 May 2019, <https://twitter.com/rocketschiller/status/1125055406114521088>.

The performance of the two systems is quite different, however. The KN-23’s range is significantly greater than that of the SS-26E (450–650 km as opposed to 300 km) and closer to that of the SS-26M. In addition, assuming that data on the SS-26E relate to quasi-ballistic trajectories with flight profiles approximately identical to those of the KN-23 (note for example that, at 50 km, the apogee of the first KN-23 tests is the same as that generally attributed to the SS-26E), the differences in range between the two systems are difficult to explain given that the approximated masses, propellant loads, and payloads of the two missiles are described as identical. The tests of 6 August 2019, with ranges of 450 km but with distinctly lower apogees (37 km), widen the performance gap between the two systems.

Figure 15. KN-23 (data from the Panel of Experts)<sup>107</sup> and SS-26E (data from open sources)

	KN-23	SS-26	KN-23 on launch	SS-26 on launch
<b>Length</b>	7.4 m	7.3 m		
<b>Diameter</b>	0.92 m	0.92 m		
<b>Launch Mass</b>	3800 kg	3800 kg (version E)		
<b>Warhead Mass</b>	400 kg	450 kg		
<b>Propellant Mass</b>	2600 kg	2300–2600 kg		
<b>Trajectory</b>	Depressed, with skipping	Depressed or ballistic manoeuvring		
<b>Maximum range without manoeuvres</b>	450 km	300 km (version E) to 700 km (version M)		

The theoretical performance gap between the SS-26E and the KN-23 may indicate that the KN-23 uses a more energetic propellant, that it has a more optimal lift/drag ratio, that its structure is significantly lighter or that its trajectory is different. The payload of the KN-23 during tests could also have been far lighter than that of the SS-26. Nonetheless, the majority of KN-23 tests have been carried out with ranges between 420 and 450 km, and it is hardly likely that North Korea would systematically test the operational performance of its weapons with reduced payloads. The test of 16 August 2019, at an estimated 690 km range, could, however, have been carried out with a lighter payload.

Although the KN-23 was designed long after the SS-26, the hypothesis that the missile is a clone of the SS-26E would imply that North Korean engineers have higher quality propellants – performances of the KN-23 being far superior to those of the SS-26E. Yet, the hypothesis that North Korean engineers would be capable of reverse engineering to reproduce a foreign missile with better performance than the original is doubtful. An alternative explanation would be that Russia has granted production licences for the SS-26E and its propellant. But there is nothing to suggest that Moscow would have the political desire to grant production licences to a state such as North Korea, and there is no evidence that it has ever issued such licences in relation to the export of the SS-26E.

<sup>107</sup> S/2020/151, op. cit.

A third, more plausible, possibility is that the KN-23 is bigger than the SS-26E and thus carries a greater propellant load. This hypothesis is consistent with the probability that, although North Korean propellants remain less high-performing than those used in an SS-26E missile, the missile itself offers higher performance.<sup>108</sup> This in no way excludes the possibility that the KN-23 was inspired by the SS-26 or even that North Korea was able to access certain technical data on the Russian missile, but it does suggest that the two systems are indeed different.

It is obviously somewhat risky to try to assess the dimensions of a missile on the basis of photographs. If we postulate that the KN-23 TEL is very similar in design to the TEL used for the SS-26 (the MZKT 7930),<sup>109</sup> it is, however, possible to deduce the dimensions of the missile on this basis.

*Figure 16. Relation between the diameter of the wheel of the MZTK 7930 launcher and the 9M720 SS-26E missile*



*Credits: Defense Update, modified by Christian Maire, FRS*

When applied to the KN-23 using a photograph taken from a similar angle, the relationship between the diameter of the MZKT 7930 wheel – which is known – and that of the missile allows us to calculate a diameter of 1.10 m and a length of 7.74 m (vice the 0.92 m and 7.4 m noted above).

*Figure 17. Relation between the diameter of the wheel of the MZTK 7930 type launcher and the KN-23 missile*



*Credits: KCNA, modified by Christian Maire, FRS*

This type of analysis naturally involves a certain degree of approximation, and assumes a strong similarity between the chassis of the two TELs.<sup>110</sup> The calculation does, however, indicate the possibility of a larger and longer missile than the SS-26E, which would help explain the differences in performance.

<sup>108</sup> Any comparison with the SS-26M, which is supposed to carry a heavier propellant load than the SS-26E and have a greater range (some experts assessing that the range of the missile with a reduced charge of 480 km may exceed 700 km), is pointless, since the trajectory of the SS-26M at maximum range is not publicly known.

<sup>109</sup> As assumed by the Panel of Experts (S/2020/151).

<sup>110</sup> The Panel of Experts' 2020 report (S/2020/151) also mentions a vehicle WS200, possibly in reference to a Chinese model made by the company Wanshan Special Vehicle, which produces artillery chassis. However, no WS200 has been identified in open sources.

Figure 18. Estimation of the possible dimensions of the KN-23

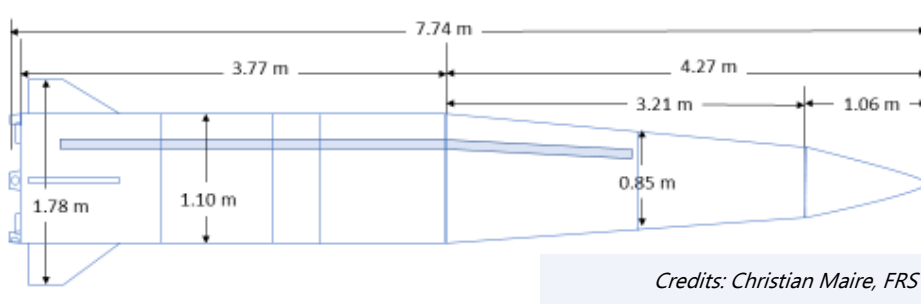

These estimates suggest a greater propellant mass and, possibly, a greater payload than that stated in the UN assessments, although the extent of the disparity is difficult to establish. For example, as shown in the diagram below, the 38th North research centre suggests dimensions for the KN-24 extrapolated from the ratio of propellant mass to missile diameter, based on known missile data. Although we cannot be certain that this analysis is applicable to the KN-24, the dimensions of which are highly atypical in relation to the reference models used in the assessment, it may apply to the KN-23, whose proportions are equivalent to those of the SS-26 used as a reference in the diagram. Based on the SS-26 (see diagram), the propellant mass of the KN-23 may be as high as 4 tonnes, knowing that the booster of the SS-26 is equally shorter than the one of the KN-23. This greater propellant mass may explain why the performance of the KN-23 is apparently comparable to that of the SS-26M despite the possibility that it may use less energetic propellants than the Russian missile and may have a greater inert mass.

Figure 19. KN-24 Propellant mass vs diameter<sup>111</sup>

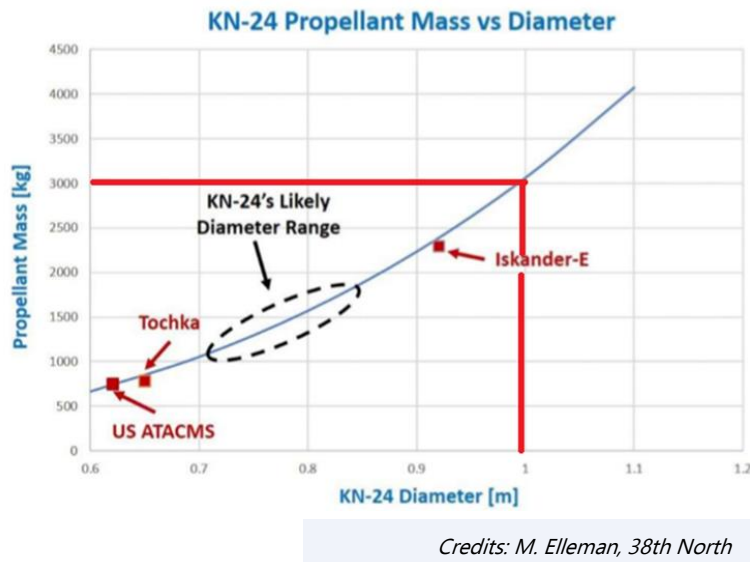

<sup>111</sup> Michael Elleman, 'Preliminary Assessment of the KN-24 Missile Launches,' *38th North*, 25 March 2020.



Figure 20. Data comparison between SS-26 and estimates for KN-23

	Length	Diameter	Propellant mass	Payload	Launch mass of missile
<b>SS-26</b>	7.3 m	0.92 m	2300–2600 kg	500 kg	3800 kg
<b>KN-23 Panel Data</b>	7.4 m	0.92 m	2600 kg	400 kg	3800 kg
<b>KN-23 (revised)</b>	7.74 m	1.10 m	+/- 4000 kg	400 kg	+/- 5200 kg

Other indications suggest significant differences between the SS-26 and the KN-23, leading to the conclusion that the two missiles, while certainly similar, are not identical. As has been widely observed, on the KN-23 the external cable duct connecting the equipment section to the propulsion system is clearly longer than on the SS-26, where it stops just after the propulsion section; the KN-23's duct stops midway along the upper part. This specific feature prompted a member state of the Panel of Experts to suggest that the payload of the missile could be relatively light so as to achieve a longer range.<sup>112</sup> Another member state instead suggested a difference in the architecture of the warhead. The duct links the guidance and navigation systems in the upper section; in the case of the SS-26, the equipment section in which these components are contained is situated immediately after the propulsion section, whereas in the KN-23 it would be situated at the end of the upper section and separated from the propulsion section by the military payload.

Such an arrangement is not unusual: it was used for example in the SS-21 and probably in the KN-02, since this solution makes it possible to leave an optimal volume for the weapons payload.

Figure 21. Volume and mass of the military payload of the SS-1c/Scud B, the SS-26 E or M, and estimation of the maximum mass of that of the KN-23 and KN23A

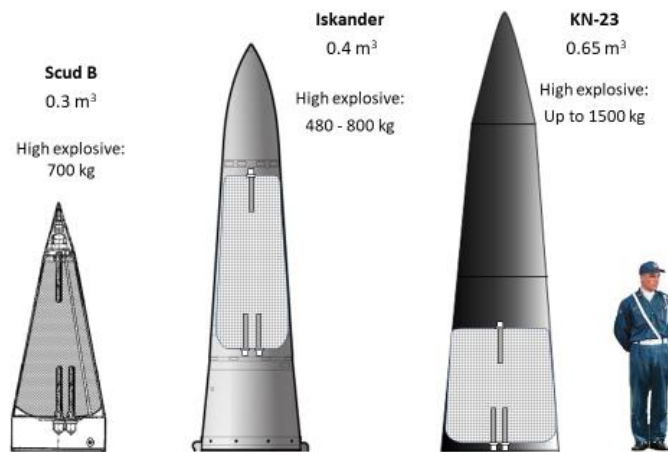

Source: Christian Maire, FRS

Based on the warhead of the SS-1c/Scud B, the possible volume and mass of the weapons payload can be extrapolated approximately. The calculation is based on the relation between the mass of the explosive in the warhead of an SS-1c in relation to the volume of the warhead, transposed to the KN-23.<sup>113</sup> According to this calculation, the KN-23 could carry up to 1500 kg of explosives, as the estimated volume of the lower part of the warhead is 0.65 m<sup>3</sup>. While the Panel of Experts estimates the KN-23's military payload to be around 500 kg, it could in reality be

<sup>112</sup> 'According to another member state, the positioning of the cable duct reaching far into the warhead compartment suggested a light warhead, in order to reach the maximum distance of around 600km.' S/2020/151.

<sup>113</sup> As the mass and density of the explosive used in the KN-23 are unknown.

substantially greater. A heavier payload would affect the range, in an order of magnitude that cannot be assessed since the mass of the payload used during the tests is not known.

Although there are significant differences between the KN-23 and the SS-26E in terms of the architecture and dimensions of the upper section, it seems highly probable that certain aerodynamic and propulsion solutions used in the SS-26E for missile control have been reused in the KN-23. Control of both missiles is based on the same two principles: deflection of the rocket exhaust, and the use of movable control fins at the base of the booster. Jet deflection enables them to manoeuvre during the boost phase both inside and outside the atmosphere, while the aerodynamic surfaces are used only inside the atmosphere, during the boost phase but also during non-powered flight. The jet vane type of deflector is a tried and tested technology that North Korea has obviously mastered, since it was previously used in the Scud B. Images of the jet vanes of the SS-26 and the KN-23 show that the construction is different in the two missiles, once again highlighting that the latter is not a simple clone of the former.<sup>114</sup>

The second point of convergence with the SS-26 concerns the coupling between the movable aerodynamic control fins at the base of the booster and the jet vanes, the aim of which is to ensure an optimal trajectory during the boost phase. The aerodynamic fins also make it possible to stabilise the missile, to ensure continual correction of the trajectory inside the atmosphere after burnout, and possibly to modify this trajectory in order to overcome defences.

*Figure 22. Activation of movable control surfaces at launch, and presence of jet deflectors on the KN-23<sup>115</sup>*

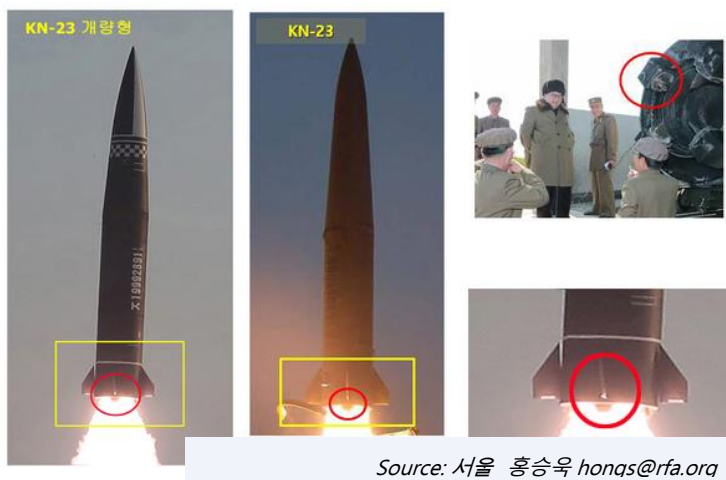

The existence of movable control surfaces confirms that the missile is capable of aerodynamic manoeuvring. Though the missile reaches no higher than 50 km at the apogee of its trajectory, the aerodynamic surfaces are effective during only a limited part of the flight, in the dense layers of the atmosphere. It can be hypothesised that when the apogee is no higher than 37 km, the missile is capable of making evasive manoeuvres all

along its trajectory. This would make it less vulnerable to missile defence systems.

The images circulated by North Korea immediately after impact during the tests, assuming the photographs have not been doctored, show that in the final phase of the terminal trajectory, the missile falls and hits the target at an angle of close to 90 degrees. The technologies necessary for this had probably already been mastered by North Korea, since the SS-21 (and therefore, in all likelihood, the

<sup>114</sup> See for example Norbert Brüggel, "It Are [sic] Extended Single-Stage Variants of the "Pukguksong-1" as GLBM-2,, [http://www.b14643.de/Spacerockets/Specials/Pukguksong\\_GLBM-2/index.htm](http://www.b14643.de/Spacerockets/Specials/Pukguksong_GLBM-2/index.htm).

<sup>115</sup> 국정원 (Hong Seung-wook), "북 미사일 KN 23 개량... 핵무기 탑재 가능" 서울 홍승욱 (North Korean missiles. Mounting Nuclear Weapons: Possible), [hongs@rfa.org](mailto:hongs@rfa.org), 29 March 2021.

KN-02), already had this capability. The image below, circulated by Pyongyang, illustrates precisely this capability in the KN-24. Lower quality images are available for the KN-23.

*Figure 23. Angle of attack in the terminal phase of flight for the KN-24<sup>116</sup>*



Source: KCNA

Although apparently anecdotal, this capability is important for conventional strikes. As demonstrated by Iran’s strike on the US Al Asad air base in January 2020, a shallow angle of penetration considerably reduces the destructive effects of munitions, making multiple strikes necessary in order to ensure destruction of the target. Vertical strike capability is important to guarantee a homogeneous distribution of effects for unitary munitions, but also for submunitions. In addition, a higher angle of penetration is imperative when striking hardened targets.

*Figure 24. Re-entry and effect of shallower angle of penetration (red circle) of an Iranian missile and orientation of the blast upon impact*



Source: CBS, 60 Minutes and GEO4i

<sup>116</sup> A hypothesis that apparently comes from Michael Elleman, 'North Korea's Newest Ballistic Missile: A Preliminary Assessment,' *38<sup>th</sup> North*, 8 May 2019, <https://www.38north.org/2019/05/melleman050819/>.

According to Western sources, the KN-23 has been documented to have performed a skipping manoeuvre during its flight. Images seen on a control screen during tests of two KN-23s on 24 July 2019 and obtained by the research centre Open Nuclear Network<sup>117</sup> show that the aim of this manoeuvre is to increase range, and it should not be seen as a pull-up manoeuvre to slow the warhead so as to increase its precision. The two tests carried out that day were made at ranges of 690 km and 430 km respectively.<sup>118</sup>

If we assume that the control screen shows the test carried out at a 430 km range (Figure 24), a very cursory assessment based on the data that appears on the screen would suggest that the skipping manoeuvre takes place at approximately 350 km range (on the axis of the Peter the Great Gulf), leading us to suppose a range extension of the order of 70 km – that is, 20% of the total distance prior to the skip. The Panel of Experts, however, estimates the KN-23's range without skipping to be 450 km, which, if we suppose the range extension of the skip to be around 20%, would suggest a total range of around 540 km.

It should be emphasised that the range of 690 km observed in the second test might suggest that the range without skipping is greater than 450 km. If we take 450 km to be the maximum range without skipping, the distance travelled during this test would be more than 50% of the initial range, which seems unlikely. This assessment is however approximate, since the payloads used for both tests are unknown.

*Figure 25. Trajectory of KN-23 with pull-up, test on 25 July 2019 (left) and (right) estimate of the first part of the trajectory (350km?)*

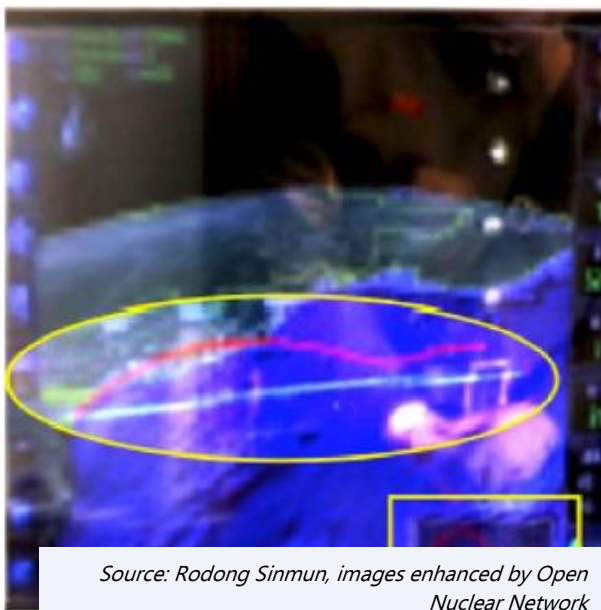

The altitude data seen on the control screen show that the skip probably occurred at around 15 km, as the apogee was 50 km. The second part of the flight was apparently made at an altitude of 25–35 km, data compatible with the known generic trajectories for this type of missile. When the trajectory is carried out with lower apogees (37 km), the gain of range induced by the skip is probably reduced and it may be expected that at very low apogees (20 km), as experimented in some KN-23 tests, the missile is maneuvering in the atmosphere but without any skipping. At low (37 km) and very low (20 km) apogees, the missile is able to maneuver all along its trajectory, further complicating interception.

<sup>117</sup> Jaewoo Shin et al. *Korea Peninsula Risk Assessment*, Open Nuclear Network, April 2021.

<sup>118</sup> CNS North Korea Missile Testing Database, *Nuclear Threat Initiative* (NTI), 2020. There is however a certain amount of imprecision on the 690 km range test, some sources placing it at 600 km. See also Kim Bomi (김보미), 'North Korea's Short-Range Missile Test Launch: Background and Implications' (북한단거리미사일시험발사의배경과 함의), Strategic paper no. 87, Institute for National Security Strategy (INSS), September 2020.

The low apogees are probably deliberately designed to make trajectory calculations more difficult for ground-based sensors – i.e. the radars of the PAC-3 and KM-SAM interception systems, and the Green Pine and THAAD early warning systems. They would not make the missiles undetectable by these sensors, since the initial portion of the trajectory remains high enough to allow detection over more than 600 km, but would make it more difficult to calculate the trajectory. The launches and their initial trajectories can be detected by US infrared early warning satellite systems (SBIRS), which makes it possible to orient all ground sensors, but the exact trajectory of the missile cannot be deduced precisely by satellites after burnout, since it does not follow a ballistic trajectory. The tracking of the missile by ground radars makes it possible to extrapolate a more precise trajectory, but the path of the missile in the lower layers of the atmosphere may enable it to modify its altitude or its azimuth, leading to errors in calculation. At altitudes below 40 km, the THAAD interceptor is also inoperative. Moreover, after the skip, the trajectory has to be entirely recalculated, and recalculated once again after the initiation of a terminal manoeuvre.

*Figure 26. Area covered by a 350km missile fired from the Sakkamol and Kal-gol bases (North Korea)*

Since the Panel of Experts places the KN-23's range without skipping at 450 km, given the short distances in the Korean theatre the missile could be fired in a configuration where the skipping manoeuvre would serve not necessarily to increase range but to help penetrate defences in combination with a terminal manoeuvre. As the missile could still have a great deal of remaining energy, the terminal manoeuvres can be quite complex, misleading the defences. At short ranges (190 km) and very low apogees (20 km), the missile is probably able to realise complex terminal evasive manoeuvres, but also pull-up manoeuvres, to slightly extend its range and radically change its direction – if need be. Given that numerous highly sensitive military, economic and political targets are situated at a short distance from the North Korean border, numerous short-range strike operations can be expected, albeit at the cost of increasing the vulnerability of the missile launch unit.

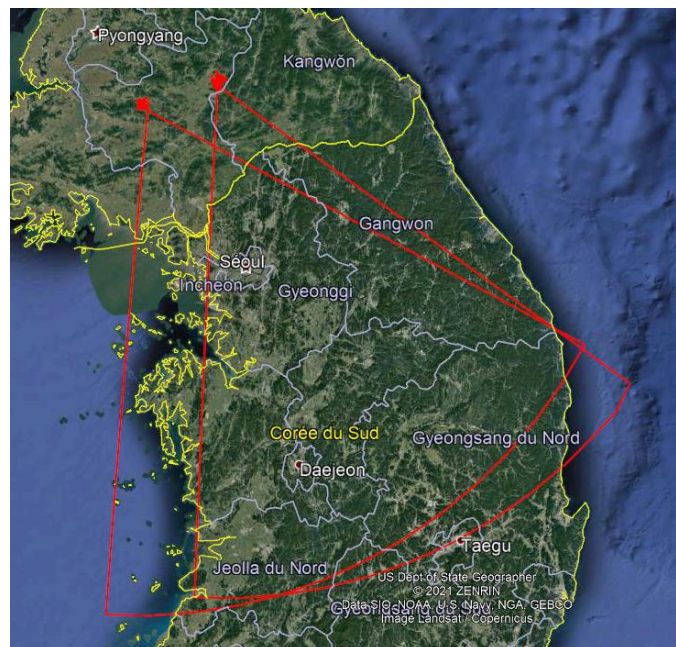

*Source: Google Earth, adapted by FRS*

Although the problem has obviously been recognised by the United States and South Korea, and solutions are already under development or even in use, particularly using IBCS-type distributed architectures,<sup>119</sup> determining the precise trajectory of a manoeuvring quasi-ballistic missile requires

<sup>119</sup> The Integrated Air and Missile Defense Battle Command System (IBCS), currently being deployed by the US Army, enables data from different types of missile and air defence sensors to be shared, allowing interceptors to make use of aggregated tracks and to engage their targets based on this data. Since interceptors are no longer exclusively dependent on their own radars, engagement ranges are greater and aggregate tracks are of higher quality. Eventually, IBCS should enable the shared use of identical radars (e.g. PAC-3 radars) and radars of different ranges (THAAD, PAC-3 and Sentinel

great computing power. The defence architecture is therefore more vulnerable to salvo fire, which can partially saturate the computing capacity as well as exhaust the stock of interceptors. In addition, whereas the AN/TPY-2 radar of the THAAD can detect and track a quasi-ballistic missile with an apogee of around 40 km,<sup>120</sup> THAAD's interceptors are inoperative against missiles flying under 40 km, and the defences designed to deal with such threats rely only on low endo-atmospheric interceptors, operating on very short range.<sup>121</sup> Layered defence, allowing for the engagement of the threat in high altitude at long range and then at low altitude at shorter range (through the deployment of THAAD and PAC-3, respectively) is less effective in this case as the first layer is nearly not operative. Solving these various problems would require a full defence architecture modernisation, something that the United States has been working on for more than twenty years, but which represents a considerable technological and financial challenge.

Finally, the existence of two types of TEL for the KN-23, one on wheels and the other a tracked vehicle, is an interesting indication of its modes of deployment. A KN-23 test carried out with a tracked chassis in the Baegong area has been revealed by a member state.<sup>122</sup> The location is not inconsistent with photographs published by North Korea, which show a missile fired from a tracked launcher on a paved road. In parallel, launches from a wheeled TEL were made from concrete structures (air base runways). The appearance of a version mounted on another, tracked, TEL – in the parade of 10 October 2020 – does not necessarily indicate that the missile can be launched from unprepared firing points, but may imply it is stationed in areas with poor road infrastructure (mountainous or highly forested areas). The KN-23 may not have the same tolerance to transit across unprepared terrain as missiles such as the KN-24 and KN-25. The launch from a train revealed on 15 September 2021<sup>123</sup> shows that survivability of the ballistic force remains one of the North Korean authorities' main concerns but may also tend to illustrate that the KN-23 is perceived as a strategic weapon. The development of the KN-23A may confirm this hypothesis.

---

radars, used for short-range air defence). Sharing data in this way should also improve how manoeuvring near-ballistic objects are tracked.

<sup>120</sup> According to Chinese sources, an X band radar detected an object flying at 1.5km/s at an altitude of 40 km for more than 800 km, the source taking as reference a hypersonic missile of type X-51, whose equivalent radar surface may be supposed to be not far from that of a quasi-ballistic missile of type KN-23 or 24. Soo Jixin Wang, 'Introducing Hypersonic Weapons (王继新)', *Ordnance Knowledge* (高高超音速武器器漫谈), n°5, 2014, cited by Tong Zhao, 'Conventional Challenges to Strategic Stability: Chinese Perception of Hypersonic Technology and the Security Dilemma,' in Lawrence Rubin and Adam N. Stulberg (eds.) *The End of Strategic Stability? Nuclear Weapons and the Challenge of Regional Rivalries*, Washington, DC, Georgetown University Press, 2018.

<sup>121</sup> The range of an interceptor such as the PAC-3 against quasi-ballistic missiles is not known, but is probably lower than the range against a ballistic missile, the interceptor losing energy when manoeuvring to adjust its trajectory. The loss of energy depends on numerous factors such as the performance of the ground radar, the algorithms used to calculate the trajectory, the type of actuator used on the missile and so on. A conservative and approximate assessment would place the maximum interception range at a few tens of kilometres.

<sup>122</sup> S/2020/151.

<sup>123</sup> Vann H. Van Diepen, 'It's the Launcher, Not the Missile: Initial Evaluation of North Korea's Rail-Mobile Missile Launches,' *38th North*, 17 September 2021.

Figure 27. Photograph of firing by KCNA and zone of firing as identified by a member state (40°01'47"N, 125°13'38"E)



Source: KCNA and Google Earth

Figure 28. Probably operational version of tracked TEL for the KN-23<sup>124</sup>



Source: KCTV and Open Nuclear Network

Figure 29. Launch of the KN-23 from a train



Source: KCTV

<sup>124</sup> Image taken from the DPRK Viewbook, October 10, 2020 Parade, *Open Nuclear Network*, 13 October 2020.

### 4.1.2 KN-23A

Featured in the military parade of 14 January 2021 and tested in two firings carried out on 25 March 2021 and then, probably, in a third firing carried out on 15 September 2021, the KN-23A appears to be a heavier version of the KN-23, of the same diameter but greater length. Extrapolation of the possible dimensions of the missile on the basis of the KN-23 suggests that the propulsion section is around a metre longer, and of equal diameter.

Figure 30. Possible dimensions of the KN-23A

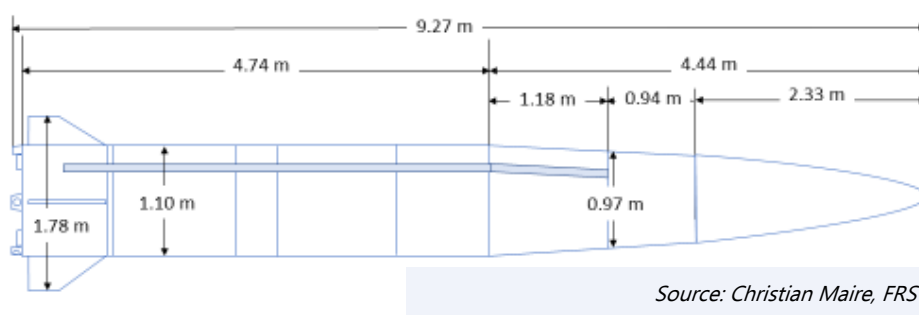
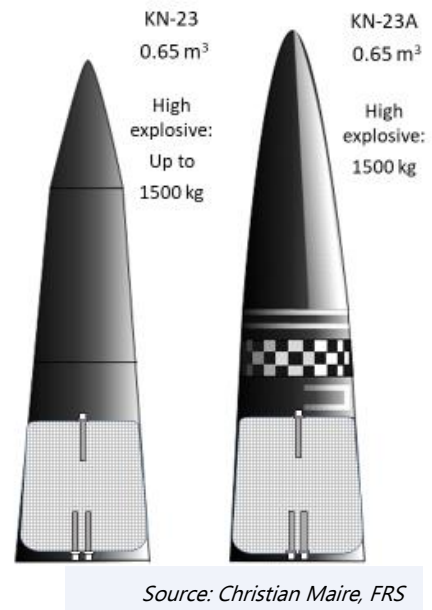

Figure 31. KN-23 and KN-23A upper sections

The tests on 25 March 2021, made at a range of 600 km, reached an apogee of 60 km, while the 15 September test firing has been estimated at 800 km with an identical apogee. The absence of any significant differences between the KN-23 and the KN-23A in the first test is explained, according to North Korean statements, by the fact that the missile had a payload of 2500 kg – which, if true, suggests that the weapons payload may be greater than 1500 kg. The design of the upper section differs quite noticeably (shape and length of the section) from that of the KN-23, even if the configuration of the military load and equipment section is probably the same, the former being probably in the lower section. The close proximity between the KN-23 and KN-23A tests, in spite of major differences in the propulsion section and apparently significant differences in the upper section, suggest that the two missiles were developed together, but in response to distinct operational needs.



The increased weight of the payload, if it exists, opens the way to numerous hypotheses. The simplest is obviously the use of heavier conventional unitary or chemical warheads, or of larger amounts of submunitions.

However, such a warhead also raises the question of the possible use of earth penetrators. As the effectiveness of the penetrator is linked, among other factors, to the speed of impact, the mass of the penetrator, the ratio between the diameter and length of the penetrator warhead and, of course, the type of materials used, the KN-23A suggests a number of possibilities. Optimal impact speeds to obtain



maximum ground penetration are around 1 km/s,<sup>125</sup> absolute speeds ranging between 1.2 and 1.5 km/s with existing materials. Such speeds could easily be attained by the KN-23A, and judicious use of the pull-up manoeuvre would probably enable the terminal speed to be adjusted with relative precision depending on the target and the mechanical strength of the penetrator. Potentially, the military payload of the KN-23A is sufficient to use a heavy penetrator, whose mass would be more than one tonne. Even though the effects of a penetrator are limited on very hard (granite-type) rock, a device of more than a tonne striking at 1km/s could probably penetrate moderately hard ground to a depth of between 10 and 20 m, and clay soils to a greater depth.<sup>126</sup> Although the use of a ballistic missile combined with an earth penetrator would be very heavily conditional upon its accuracy, the KN-23A answers well enough to the definition of a weapon for which a heavy penetrator could be adapted for conventional bunker strikes. North Korean technological expertise is probably insufficient to anticipate the coupling of the penetrator with a nuclear warhead. As it stands, the possibility that KN-23A may be used for conventional precision strikes against hardened infrastructures remains hypothetical.

The KN-23A could be coupled with a nuclear weapon even if the heavy payload suggests a non-nuclear mission.

### 4.2 KN-24

The KN-24 is a solid-fuel single-stage ballistic missile with a non-separating warhead, launched from a mobile launcher. It is generally considered to be very similar to the US MGM-140 heavy guided rocket (ATACMS). The UN Panel of Experts estimates the characteristics of the missile to be as follows.

Figure 32. KN-24 (Panel of Experts data)<sup>127</sup> and MGM-140 (data from open sources)

	KN-24	MGM-140	KN-24 at launch	MGM-140 at launch
<b>Length</b>	5.7 m	4 m		
<b>Diameter</b>	0.97 m	0.61 m		
<b>Launch mass</b>	2900 kg	1600 kg		
<b>Mass of head</b>	400 kg	230 kg		
<b>Propellant mass</b>	2000 kg	700 kg		
<b>Trajectory</b>	Depressed, with pull-up manoeuvre	Depressed without pull-up manoeuvre		
<b>Maximum range</b>	300–400 km	300 km		

*Source: KCNA and US Army*

<sup>125</sup> National Research Council, U.S. Conventional Prompt Global Strike: Issues for 2008 and Beyond, 2008, p. 108.

<sup>126</sup> Committee on the Effects of Nuclear Earth-Penetrator and Other Weapons, National Research Council, *Effects of Nuclear Earth-Penetrator and Other Weapons*, 2005.

<sup>127</sup> S/2020/151, op. cit.

The assessments from the Panel of Experts show that the KN-24 is a significantly different missile from the MGM-140, to which it bears only a visual resemblance. An assessment of the size of the missile based on photographic data results in conclusions relatively similar to those of the Panel for the diameter, but a slightly different assessment for the length and mass.

Assuming that the TEL used for the KN-24 is similar to the M270 used for the MGM-140 and that their width is relatively similar (2.98 m for the M270, rounded up to 3 m in the estimates here), the relationship between the TEL and the diameter of the missile gives a potential diameter of 0.96 m. If it is supposed that the chassis of the TEL is derived from the T-62, whose width is around 3.30 m, the missile would be slightly larger than assumed here.

Figure 33. Relation between the width of the TEL and the diameter of the KN-24



Source: KCNA, modified by Christian Maire, FRS

Retaining the reference value of 3 m for the width of the TEL but using the missile launching canister as comparison, the apparent diameter of the missile is 1 m.

Figure 34. Dimensions of the TEL and diameter of the missile



Source: KCNA, modified by Christian Maire, FRS

Figure 35. Visual comparison between the MGM-140 (top) and the KN-24

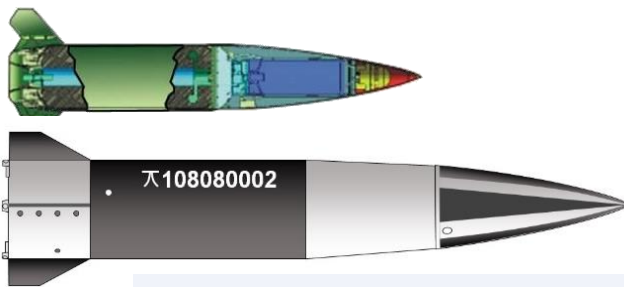

Extrapolating the diameter of the missile in order to deduce its length, we come to a different conclusion from the Panel of Experts, with an estimate of the length of the missile to be 6.37 m, as opposed to 5.70 m. Figure 35 illustrates the difference in dimension between the KN-24 and the MGM-140.

Source: Christian Maire, FRS

Figure 36. Possible dimensions of the KN-24 missile

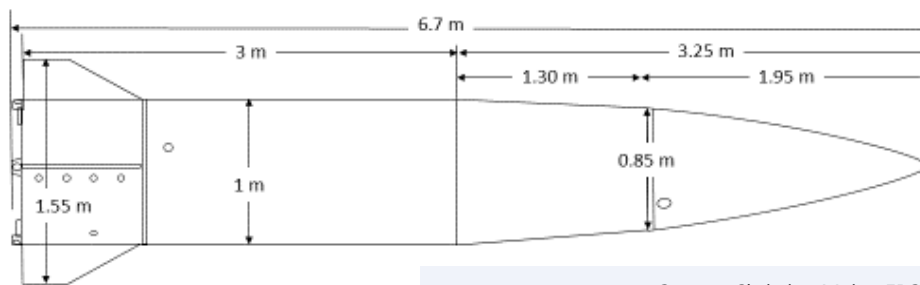

Source: Christian Maire, FRS

Different conclusions can also be drawn regarding the propellant mass used. This estimate is important in evaluating the range and possible trajectories of the missile. The Panel of Experts estimates the propellant mass to be around 2000 kg, and the range to be 300 km without pull-up<sup>128</sup> as opposed to 450 km for the KN-23.

From this point of view, the figures provided by the CNS tests database raise questions as to the estimation of range.<sup>129</sup> The tests carried out between August 2019 and March 2020 were in fact of two different types. The first series of tests, at what is probably maximum range (400 km for the test of 9 August 2019 on an apogee of 48 km, and 410 km for the two tests carried out on 20 March 2020 on an apogee of 50 km), given the apogees, were probably carried out with a skipping manoeuvre. Two other tests, carried out on 19 August 2020, were on a low apogee (30 km) and at short range (230 km). These two tests were probably carried out without a skip, but possibly with a series of manoeuvres. The two series of tests do not allow us to deduce the exact range of the missile without a skip, as the short-range tests apparently were executed in a configuration designed to optimise manoeuvrability, at the cost of a longer range. It should also be emphasised that the aerodynamic characteristics of the KN-24 are probably inferior to those of the KN-23, since the low apogee tests of the two missiles (37 km for the KN-23 and 30 km for the KN-24) show that their ranges differ significantly (230 km for the KN-24 as opposed to 450 km for the KN-23).

While it is possible to extrapolate data on the KN-23 on the basis of the SS-26 given their very strong resemblance, no such analysis is possible for the KN-24 since, in spite of its visual resemblance to the

<sup>128</sup> S/2020/151.

<sup>129</sup> CNS North Korea Missile Testing Database.

MG-140 heavy rocket, the dimensions of the KN-24 are far larger while its performance, as a result of the propellant mass and possibly the payload, is inferior. It should be noted, however, that, as for the KN-23, the propellant mass of the KN-24 could be significantly greater than is generally envisaged, as, of course, could be the missile's launch mass.

Figure 37. Possible configuration of the warhead of the KN-24

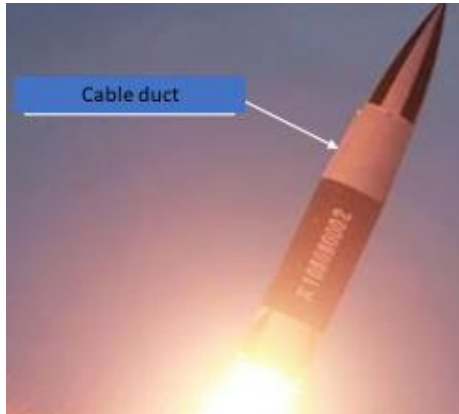

Source: KCNA, adapted by Christian Maire,

Like the KN-23, the KN-24 appears to have a cable duct that rises just to the top part of the upper section. The payload may therefore be located in the lower part and the equipment section in the upper part. If this is indeed the configuration, the volume reserved for the payload would be approximately the same as for the KN-23. The choice of possible payloads could therefore be rather wide and could contribute towards explaining the very short ranges observed in some of the tests.

Figure 38. Comparison with KN-24 payload section

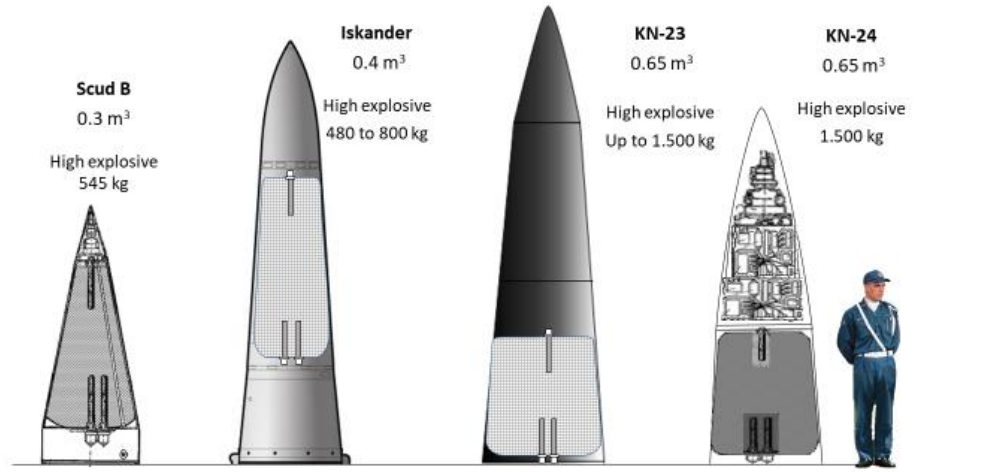

Source: Christian Maire, FRS

Missile control during the boost phase is handled by four jet vanes positioned at the level of the main motor rocket nozzle outlet. The missile is stabilised by four control surfaces, which are probably movable as on the KN-23. The movable control surfaces can be effective throughout most of the flight, and also enable low-altitude manoeuvres in order to avoid defences and to ensure precision.

The guidance and navigation of the missile are handled by an inertial navigation system, probably coupled with a GNSS receiver. The existence of a terminal sensor, radar or other, is a possibility, but like GNSS, there is no specific evidence for it.

The KN-24 is launched from a tracked vehicle equipped with two canisters of square cross section, the length of which can be estimated at around 7 m. The chassis could potentially be derived from a modification of the T-62 chassis (with an additional axle) or the T-72 – as the Pokpung Ho tank, shown in 2010, is usually described as one or the other.<sup>130</sup> If the Pokpung Ho is derived from the T-62 or T-72, the dimensions arrived at here for the KN-24 are probably fairly accurate.

The decision to use a tracked TEL, and certain launch positions used during the tests, seem to suggest that the KN-24 is a weapon designed for all-terrain use, following the logic of heavy guided rockets of the ATACMS type (MGM-140/164) provided to long-range artillery units, possibly with the aim of supporting ground units. Its use over short ranges supports this idea, although given the theoretical range of the missile we may also envisage it being used in combination with the KN-23 against targets located deeper into South Korean territory.

The KN-24 programme thus appears to differ significantly from the KN-23 programme, both in its probable military objectives and in its technological and possibly political aims. As highlighted above, the KN-23 programme has probably been underway for a long time and required acquisition of foreign data and technologies. Although this does not necessarily imply active proliferation on the part of Russia, all the less so given that we might envisage complementary acquisitions being sourced from nearby regional programmes (Ukraine's Grom, South Korea's Hyunmoo 2 and even China's M-20), realisation of the programme must have been dependent on know-how, components, materials and software solutions sourced from elsewhere. As such, although the KN-23 meets a strong operational demand on the part of the North Korean forces, and ultimately suggests that Pyongyang may have mastered the associated technologies, the considerable complexity of the latter and the significant effort required to acquire them, along with the development of industrial means and securing access to those components and materials that are technically beyond the reach of North Korean industry, suggests that the KN-23 programme has long represented a high-risk project.

The decision to initiate the KN-24 programme may have been taken earlier than for the KN-23 programme, since the performance of the MGM-140 made clear the value of such a system to North Korea from its use in 1991. Unlike the KN-23 programme, which quite closely adopts certain characteristics of the SS-26, the KN-24 programme seems to point to a process of reverse-engineering based on very partial observation or acquisition of a given weapons system, resulting in the development of a derivative system using domestically produced solutions.

This can be seen in the design of the propulsion unit, with the very significant difference in dimensions suggesting the use of a far less energetic propellant than in the US missile. It is also evident in the control system, as the US missile does not use a jet deflector for control of the boost phase. North Korea may have been able to carry out an initial evaluation of the MGM-140, for example on the basis of remains of the systems used in Iraq. Conversely, it is highly unlikely to be based on the BRE-8 Chinese variants, which are quite similar to the MGM-140 but appeared on the market much later, and are far smaller than the North Korean model.

---

<sup>130</sup> Kyle Mizokami, 'FACT: North Korea Has Thousands of Tanks (But Can They Fight?)', *The National Interest*, 7 September 2019, <https://nationalinterest.org/profile/kyle-mizokami>.

Apart from the differences resulting from the propellant mass used and the estimated precision of the missiles, the asymmetry in performance between the KN-23 and KN-24 may be related to the use of materials and components available only in North Korea at the time of design, as well as to the hardy nature of the KN-24, which based on the tracked launcher is designed for use on the battlefield. Nonetheless, the fact that the KN-23 and KN-24 tests were carried out at the same time suggests that the technical solutions used for one or the other of these programmes were reused, such as the propellants, the inertial navigation and its hybridisation with a GPS receiver, and any terminal guidance system that may be used.

The idea that the KN-23 is a 'non-national' programme while the KN-24 is a purely domestic programme has also been assessed from a semantic angle by two researchers<sup>131</sup> who have closely examined the words used in North Korean media associated with the development of the weapons, as well as the term 'strategic autonomy' used in official descriptions. As the authors emphasise, from this point of view the terminology used for the KN-23, essentially military in nature, seems to show that the system is already operational. This interpretation tends to be corroborated by the launches, since the KN-23 has been tested in combination with other systems. Official statements regarding the KN-24 are of an entirely different nature, with numerous references to research and development seeming to suggest that the weapon is not yet operational. After flight tests in January 2002, North Korea stated that the missile was in a phase of evaluation, prior to a potential deployment.<sup>132</sup> Most importantly, the KN-24 programme is particularly strongly associated with the Korean word 'Juche', meaning 'self-reliance', including in the political sense of the word, but this is never used in relation to the KN-23. The researchers conclude that the KN-24 is a domestic programme, corroborating the technical observations.

### 4.3 KN-25

Unlike the KN-23 and KN-24, the KN-25 is not a quasi-ballistic missile but a ballistic weapon. Although its range, observed at a maximum of 380 km, may result in its being classified as a ballistic missile, its design is that of a guided artillery rocket. One of the principal differences between a missile and an artillery rocket concerns the launch trajectory: artillery rockets can be fired on extremely flat trajectories, allowing low apogees without use of quasi-ballistic trajectories.

The data from the UN Panel of Experts describe an extremely large rocket with a non-separating warhead, more than 8 m long and 600 mm in diameter, with a propellant mass of 2400 kg – significantly higher than the Panel's estimate of the KN-24 – and a launch mass of 3500 kg, making the KN-25 one of the most massive artillery rockets currently in deployment, with possibly the highest range among single-stage rockets identified to date.

---

<sup>131</sup> Tianran Xu and Jaewoo Shin, 'A Tale of Two Missiles: Analysis of KCNA Reports on North Korea's KN-23 and KN-24 Short-Range Ballistic Missiles,' *Datayo*, April 2020, <https://datayo.org/p/stories/8jzpzJxnZhMCzDA6/a-tale-of-two-missiles-analysis-of-kcna-reports-on-north-koreas-kn-23-and-kn-24-short-range-ballistic-missiles>.

<sup>132</sup> Vann H. Van Diepen, 'Implications of North Korea's January 14 and 17 Short-Range Ballistic Missile Launches,' *38<sup>th</sup> North*, 25 January 2022, <https://www.38north.org/2022/01/implications-of-north-koreas-january-14-and-17-short-range-ballistic-missile-launches/>.

Figure 39. KN-25 (Panel of Experts data)<sup>133</sup>

	KN-25	KN-25 at launch
Length	8.1 m	
Diameter	0.60 m	
Launch mass	3500 kg	
Warhead mass	300 kg	
Propellant mass	2400 kg	
Trajectory	Ballistic	
Maximum range	380 km	

The KN-25 has attracted less attention than the KN-23 and the KN-24. As heavy artillery rocket technology is more accessible, it appeared to be a relatively ordinary system. In fact, it may represent a real breakthrough.

#### 4.3.1 The KN-09 as the probable basis for the acquisition of technological know-how

North Korea deployed its first modern heavy guided rocket in the early 2010s: the KN-09, which has a diameter of 300 mm. Although the deployment of the KN-09 attracted no particular interest, it marked another stage in the North Korean acquisition of ballistic missile technology. The rockets deployed by North Korea up until this time can be divided into two categories: 122 mm rockets, initially based on the Soviet 9M22 used on BM-21 rocket launchers and widely exported during the 1960s, and the 240 mm rockets of the M1987 and M1991 systems, which emerged in the early 1980s and are generally described as being domestically produced but may nonetheless have been derived from 220 mm Soviet 9M27 rockets, which were also widely distributed. It is very difficult to develop the motors for such rockets, which use so-called 'double base' propellants, into more powerful motors. Any substantial increase in range requires an increase in diameter and the use of more complex, so-called 'composite' propellants.<sup>134</sup> It is unsurprising therefore that the development of larger North Korean artillery rockets

<sup>133</sup> S/2020/151, op. cit.

<sup>134</sup> From this point of view, the hypothesis that the KN-09 is a further development of the M1987 and M1991 240 mm rocket systems does not necessarily seem plausible. On this hypothesis, see Lee Ho-ryeong (이호령), 'North Korea's New Large-Caliber and Extra-Large Multiple Rocket Launcher Development Objectives and Countermeasures (북한의신형대구경·초대형 방사포개발목적과 대응방향),' *Korea Institute for Defense Analysis (KIDA), External Academic Activities Series 2020-21*, 30 April 2020.

coincided with the emergence of domestic production capability for composite propellants over the course of the 2000s, leading to the design of the KN-09 (300 mm) rocket in the early 2010s.

The coincidence between the development of a composite propellant production capability and the appearance of the KN-09 does not, however, prove that the KN-09 is a domestically developed system or the result of an imported system being reverse engineered. Although its 300 mm diameter has led most analysts to compare it to the 9M55 rocket used by the Russian BM-30, the performance of the two weapons is very different, with the KN-09's range being 190 km as opposed to 90 km for the Russian rocket, and a payload thought to be approximately identical.<sup>135</sup> It has also been suggested that the KN-09 could be derived from the Chinese PHL-03 system produced by NORINCO, itself derived from the BM-30 and described as being capable of reaching a range of 130 km with a lighter payload.

The inconsistencies between the reference rocket (Russian 9M55 or Chinese model) and the KN-09 may indicate that the provenance of the technologies could lie with the second largest producer of Chinese rockets, the Sichuan Aerospace Industry Corporation, which produces the Weishi (WS) rocket series. Although this cannot be confirmed, devices such as the WS-1B, with a 180 km range, may be the technical source for the KN-09.<sup>136</sup> The China Precision Machinery Import-Export Corporation (CPMIEC) has been widely promoting this type of hardware for export for the last twenty years.

Even if the KN-09 is not a North Korean version of the WS-1B, as the latter does not have a trajectory correction system comparable to that of the KN-09, the hypothesis of a Chinese technological source is interesting in many respects. China has made major developments in 300–400 mm diameter rockets since the 1990s, outclassing Russian systems which, in this category of rockets, have developed very little over the same period. The WS-1B rocket is sometimes described in open sources<sup>137</sup> as using composite propellants with HTPB (polybutadiene) binders, one of the most energetic families of propellants. This type of technology is of major interest to Pyongyang, which may have been looking to Chinese channels in order to develop its capacity. However, large-scale industrialisation remains challenging, and North Korea has never been publicly identified as a possible producer of HTPB.<sup>138</sup>

Regardless of the propellant used in the KN-09, it seems likely that this programme represented a major breakthrough in the process of designing and producing heavy rockets and solid-propellant missiles in North Korea, since the KN-09 has a theoretical performance close or equal to that of leading global producers, and surpassing that of Russia. Although the Chinese and Americans have already partially or completely made the transition to more modern systems, North Korea has shown with the KN-09 that its industry has reached high standards in terms of propulsion but also guidance and navigation. The KN-09 was the first North Korean weapons system to rely on a control system using movable

---

<sup>135</sup> For an analysis of the KN-09, see Peter D. Zimmerman, 'Assessing the DPRK's KN-09 300 Mm Multiple Rocket Launcher System: Decisive or Incremental?', *NAPSNet Special Reports*, 10 June 2018, <https://nautilus.org/napsnet/napsnet-special-reports/assessing-the-dprks-kn-09-300-mm-multiple-rocket-launcher-system-decisive-or-incremental/>.

<sup>136</sup> A hypothesis also put forward by Michael Elleman, 'North Korea's Newest Ballistic Missile: A Preliminary Assessment,' op. cit.

<sup>137</sup> '302 mm Multiple Launch Rocket System WS-1B (WS-1)', *Missilery.Info*, <https://en.missilery.info/missile/ws-1>.

<sup>138</sup> See the *MTCR Handbook* ([https://nuke.fas.org/control/mtrc/text/mtrc\\_handbook.pdf](https://nuke.fas.org/control/mtrc/text/mtrc_handbook.pdf)). The producers of HTPB and equivalents (PBAN, CTPB, etc) listed by the MTCR includes only China, the US, France, India, Japan, and Russia. This begs the question as to what binder is used for North Korean propellants derived from those of the SS-21.



aerodynamic surfaces. Although it is certain that the KN-09 has inertial guidance at least, since such a solution is necessary for artillery rockets with a range of over 40 km, which are subject to significant drift, the first photographs published by North Korea were designed to show the precision of the rocket, demonstrating the probable use of GNSS guidance since inertial guidance is insufficient to have a metric accuracy. It cannot therefore be ruled out that North Korea mastered GNSS/inertial hybrid guidance between the early and mid-2010s. Given the dissemination of this technology on the market for small-diameter rockets, in particular 122 mm models, such a development would not be at all surprising.

*Figure 40. Precision strike by KN-09, photograph published in 2016<sup>139</sup>*



### 4.3.2 Specific features of the KN-25

The emergence in 2019 of a heavier version of the KN-09 built around a 400 mm motor led some to think that the development towards a 600 mm rocket (KN-25) was a relatively straightforward process.<sup>140</sup> Yet the two-fold increase in diameter from the original KN-09, as well as the significant increase in range, required relatively specific solutions.

Fired at maximum range – 380 km – the apogee of the KN-25 would be around 100 km, following a ballistic trajectory. This type of artillery rocket is not spin-stabilised,<sup>141</sup> and is therefore controlled solely by the four control fins situated on the upper part of the rocket. In this flight configuration, the KN-25 behaves like a ballistic missile, but with most of its trajectory being confined to the higher layers of the atmosphere. Aerodynamic control is used essentially only during the boost and terminal phases, with

<sup>139</sup> Dylan Malyasov, 'Photos of North Korea Army Practices Military Exercises with KN-09 Rocket Launcher System,' *Defence Blog*, 7 March 2016, <https://defence-blog.com/photos-of-north-korea-army-practices-military-exercises-with-kn-09-rocket-launcher-system/>.

<sup>140</sup> Lee Ho-ryeong (이호령), 'North Korea's New Large-Caliber and Extra-Large Multiple Rocket Launcher Development Objectives and Countermeasures,' op. cit.

<sup>141</sup> Certain models of rockets contain a pyrotechnic apparatus (one or more spin motors) to induce rotation, used at launch to stabilise the airframe. These apparatuses do not seem to be present in the KN-09 and KN-25 and in general are only used for stabilisation, not for control.

the rest of the flight unguided. During controlled flight, it is guided by the inertial navigation and any GNSS receiver.

North Korean engineers have come up with an original solution to ensure stabilisation of the rocket. The rocket has six retractable fixed control surfaces arranged in opposing pairs (see photo), which are not used to keep the rocket rotating, as is the case for many artillery rockets,<sup>142</sup> including the KN-09.<sup>143</sup> The absence of any use of rotation can be explained by North Korea's desire to make the KN-25 suitable for light launchers, as well as by the difficulty of initiating the rotation of rockets of this length/diameter ratio.<sup>144</sup> In any case, the absence of spin-stabilisation, along with the opposing placement of the control surfaces, seems to suggest that the rocket is designed to be stable on its axis. Stability is likely also assured by the canards on the upper section, which also enable control of the missile during flight. It therefore seems probable that the KN-25 was not designed as a conventional spin-stabilised artillery rocket and thus differs substantially from the KN-09.

*Figure 41. Opposing retractable control surfaces (back of the rocket) and attitude control surfaces (front of the rocket)*

It is relatively difficult to estimate the accuracy of the KN-25 when fired at maximum range, following a conventional ballistic trajectory. If we assume the use of a second-generation (strapdown) inertial navigation system which, schematically, should ensure accuracy of around 0.1% of the range, then the circular error probable (CEP) would be around 400 m. The level to which CEP is reduced by having guidance in both the boost and terminal phases is difficult to assess. Since re-entry would have to take place at high speeds of around 1.5 km/s, the four canards situated on the upper part may be insufficient to ensure the same level of accuracy as that estimated for the KN-23 and KN-24.

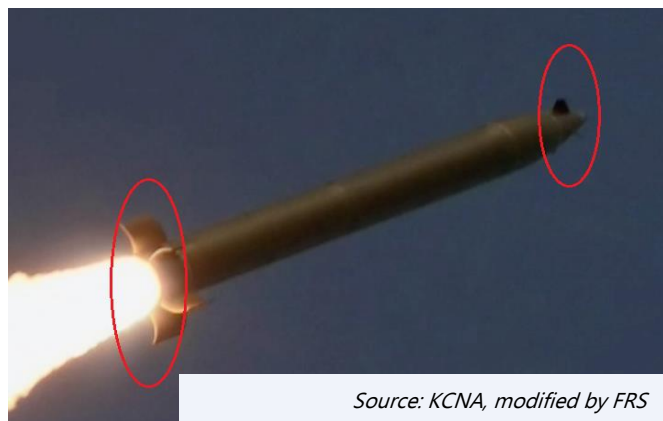

*Source: KCNA, modified by FRS*

One indication of a possible lack of accuracy at long-range may be evident in the trajectories of the tests. Although the KN-25 was tested at maximum range (that is, 380 km on apogees between 90 and 97 km) on six occasions, nine tests were carried out on lower apogees, with a first series at 50 km and then subsequent tests at 35 km, 30 km and 25 km. Apart from two firings made at 330 km range, the observed ranges in firings on a 50 km apogee are not noticeably greater than those observed on a 35 km and

<sup>142</sup> The aim of the rotation, when slow, is to attenuate any asymmetry in propulsion or drag. Rapid rotation makes it possible to stabilise the device. These solutions are used in almost all artillery rockets, old and new. See Ove Dullum, *The Rocket Artillery Reference Book*, Norwegian Defence Research Establishment, 2010.

<sup>143</sup> On this point see Xu Tianran, 'Analysis of the KN-25 Multiple Rocket Launcher System after the 9 March 2020 DPRK Test,' *Datayo*, 23 March 2020.

<sup>144</sup> According to Ove Dullum, 'After the release of the rocket, friction between the rocket and the launch tube will inflict some recoil, but this is quite small. If spin is induced by the launch tube, the rotational momentum must be counter-balanced by an equal momentum to the launcher. Usually the inertial moment of the launcher by far exceeds the axial inertial moment of the rocket. The turning of the launcher will thus be minimal. However, for light launchers this effect may be significant.' Ove Dullum, *The Rocket Artillery Reference Book*, op. cit.

30 km apogee (200 km for firings on a 50 km apogee as opposed to 230–240 km for firings on apogees of 30 and 35 km). It is quite probable that the aim of this last series of tests was to evaluate the maximum range possible with very flat trajectories, which probably would serve to ensure aerodynamic guidance of the missile throughout a longer part of the trajectory and thus obtain significantly higher accuracy.

The similarity of ranges in the tests on 50 km and 30/35 km apogees suggests that the operational range of the missile may be between 200 and 250 km. Moreover, the majority of tests have been carried out on such ranges.<sup>145</sup> This would be broadly sufficient to reach all military targets in north and central South Korea from the first belt of bases situated around 60 km from the demilitarised zone (DMZ), given that the configuration of the weapons system, light and very mobile, enables it to operate closer to the border.

The low apogee tests are also interesting, because they show that maximizing range was probably not North Korea's primary objective. Apart from the fact that inertial accuracy will be lower at maximum range, the KN-25's capacity to reach ranges of over 200 km on apogees around 30 km may seem surprising. By way of comparison, the apogee of a 300 mm Russian 9M55 rocket is estimated to be 24 km when fired to a 70 km range.<sup>146</sup> Taking into account the apogee, the KN-25 is therefore capable of achieving considerable ranges, by virtue of the large propulsive mass of the missile. It is highly likely that the device was specifically designed to follow this type of trajectory, and thus to operate over shorter ranges than the KN-24. The speed of the rocket, which is probably greater than 1 km/s, the very short flight time, and the very low apogee also make it very difficult to intercept.

Optimising the rocket for very flat trajectories may have required North Korean engineers to use rigid structural materials. The KN-25 may therefore be relatively heavy. A high structural rigidity would also facilitate its off-road deployment. The various launch vehicles used confirm that the KN-25 can be deployed on relatively light vehicles. The rocket is deployed on a tracked TEL in its six-launcher version, but also on a derivative four-axle mobile launcher, an extremely mobile chassis that can be used on very varied terrain, and which allows the rapid evacuation of firing zones, limiting exposure to counterfire.

The fact that the KN-25 is designed for artillery use can also be seen in the way it is fired. The successive tests were systematically carried out in salvos (two or three weapons fired) with a reduction of the time elapsed between each firing from the same launcher. The rate of fire is estimated at four rockets in less than a minute.<sup>147</sup> The weapon has been heavily tested between 2019 and October 2022 with no less than 19 events totalling 38 missiles. The intensity of this test campaign is exceptional and illustrates very clearly the major importance of this weapon system for North Korea.

The very specific characteristics of the KN-25 suggest that the system is of domestic design. Unlike the KN-09, KN-23 and KN-24, the rocket does not seem to have been produced by reverse-engineering or derivation but rather reflects North Korea's own development capabilities, probably in response to the very specific demands of the armed forces. The various press releases reporting the tests seem to imply this, since the vocabulary used in connection with the KN-25 is similar to that used for the KN-24.<sup>148</sup> As such, the development of the KN-25 is probably an important event, as it shows that North Korea is now capable of producing very high performance weapons systems, possibly with minimal assistance from

---

<sup>145</sup> CNS North Korea Missile Testing Database.

<sup>146</sup> Ove Dullum, *The Rocket Artillery Reference Book*, op. cit.

<sup>147</sup> Joseph Dempsey, 'Assessment of the March 9 KN-25 Test Launch,' op. cit.

<sup>148</sup> Tianran Xu and Jaewoo Shin, *A Tale of Two Missiles*, op. cit.

outside. South Korea has stated that it was developing C-RAM technologies,<sup>149</sup> but the system is not scheduled before 2035<sup>150</sup>, showing that South Korea has been caught off-guard by the successful development of the KN-25 (and possibly by that of the KN-09). The recurrence of the tests may compel Seoul to buy a foreign system before 2035, while knowing full well that existing C-RAM systems, including the Israeli Iron Dome are still not well suited against this kind of heavy rockets.

#### 4.4 Assessment of missile accuracy

It is not possible to assess the accuracy of the missiles on the basis of what is known about the guidance systems of North Korean missiles. Moreover, if we assume that navigation and terminal guidance – at least in the tests – use a GNSS signal, the accuracy will not be equivalent to that observed in the modern quasi-ballistic missiles developed by Russia, China and the United States, which can be less than 10 or even 5 m. Although GNSS makes it possible to precisely locate the missile position at a given moment, the accuracy still remains dependent on the capacity of on-board navigation systems (and also on the performance of the control surface actuators) to calculate and define an optimal trajectory on the basis of the situational data available. In addition, a skipping manoeuvre, which may be used in combination with evasive manoeuvres, can affect the aerodynamic behaviour of the missile and may generate further deviation of the real position of the missile from an ideal trajectory, affecting accuracy.

North Korea's communications strategy does, however, enable us to venture some assessments. For some years now, North Korea has publicised the development of its strike capability by demonstrating what it portrays as the growing accuracy of its delivery systems. This approach was first demonstrated by photographs showing KN-09 rockets hitting a rocky islet and has since been used consistently, reproduced for the tests of the KN-23, the KN-24, and the KN-25.

The impact area used by North Korea has proved easy to identify, especially since Pyongyang has made no efforts to conceal it. Apart from the photographs published by North Korean media, the North Korean forces' communications service allowed the zone to appear on the screens of the local PCs used by Kim Jong Un. It is a rocky islet named Al-som situated around 15 km into sea (40°38'54.13"N129°32'46.21"E), off the coast of the town of Hwadae. The site is used for numerous firing exercises, which makes it difficult to precisely identify a particular strike during the course of an exercise encompassing different types of missile or artillery units, particularly using radar imagery (see below).

---

<sup>149</sup> Counter Rocket, Artillery and Mortar: a system for the short-range interception of threats such as artillery shells, mortar shells and rockets, but also missiles operating at low altitude and relatively low speeds.

<sup>150</sup> 'S. Korea to develop 'Iron Dome'-style defence system to counter North's artillery', *Reuters*, 28 June 2021, <https://www.reuters.com/world/asia-pacific/skorea-develop-iron-dome-style-defence-system-counter-norths-artillery-2021-06-28/>.

Figure 42. Explosion during the test of a KN-24, silhouette of the islet of Al-som on the control screen used by Kim Jong Un



The islet is quite small in size. Its usable area, i.e. the area with sufficient length and width to be employed as an impact area, is 420 m long by 70 m wide. The August 2019 launches which North Korea associated with a detonation on the islet of Al-som, included one launch of the KN-23 (6 August), one launch of the KN-24 (9 August) and one launch of the KN-25 (1 August), the latter remaining unconfirmed but heavily suspected.

These tests show that the central zone of the islet was probably targeted. Taking the orientation of the firings into account, it is possible to estimate the potential diameter of the impact zone. In this way, the KN-23 firing on 6 August from the Kwail air base (460 km from the islet), like the KN-24 firing on 9 August 2020 from Hungnam (39°48'43"N 127°39'49"E, 185 km from the islet), show that the general axis of fire passes across the width of the island. The location of the launch of the KN-25 is less certain and should be around the town of Yonghung according to South Korea's Joint Chiefs of Staff (JCS),<sup>151</sup> giving a similar axis.

Based on the Kwail/Hungman-Al-som islet axis, the KN-23 and -24's CEP can be placed at around 80 m, since the maximum width of the islet on this axis is 180–190 m. It is, however, difficult to evaluate the exact CEP, since we do not know the intended target point and therefore have to base the CEP assessment on a theoretical one. According to the zones identified – for example the widest part of the islet's central zone, which is 70 m wide – the CEP can be estimated at around 35 m. Targeting the adjacent central zone, to the left, would yield an approximately equivalent CEP. The various images of impacts associated with the firings of the KN-23 and the KN-24 on 6 and 9 August 2019 lend weight to the hypothesis that one of the two central zones was indeed targeted.

The firing of 1 August 2019, which has long been listed as unidentified, is now usually attributed to a KN-25, also giving an estimation of the accuracy of the rocket.<sup>152</sup> Taking into account the approximation of the location of the launch, the axis is retained here is hypothetical. Nonetheless, the impact appears to be on the wider part of the islet. If it is supposed that this area was effectively targeted, the accuracy of the missile would be lower than that of the KN-23 and KN-24. The length of the area along the supposed axis being 188 m, the CEP may be around 80–90 m.

<sup>151</sup> 'N Korea conducts third weapons test in eight days,' *BBC News*, 2 August 2019, <https://www.bbc.com/news/world-asia-49199157>.

<sup>152</sup> S/2020/151 and CNS North Korea Missile Testing Database, op. cit.

Figure 43. Possible axes of firing from the firing site of Yonghung (KN-25?), from the Kwail air base (KN-23) and from the firing range of Hungnam (KN-24) in relation to zones of detonation attributed to each missile on the islet of Al-som

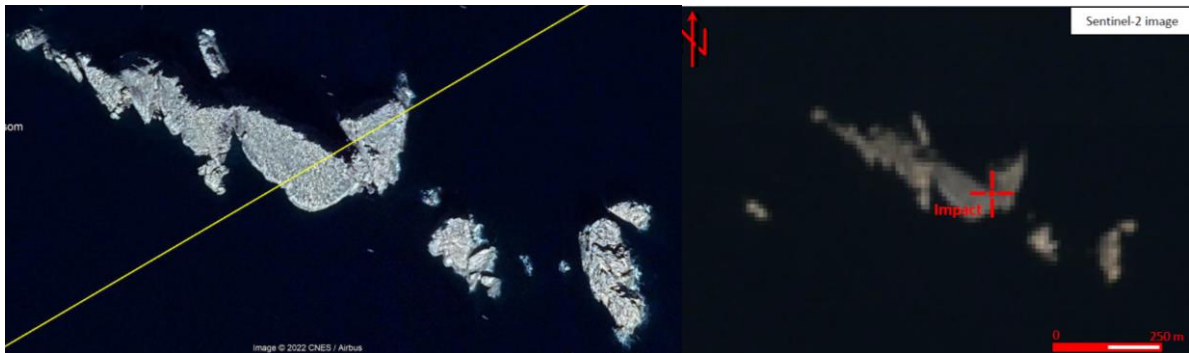

**KN-25 POTENTIAL AXIS OF FIRING (LAUNCH LOCATION NOT EXACTLY KNOWN) AND SUPPOSED IMPACT**

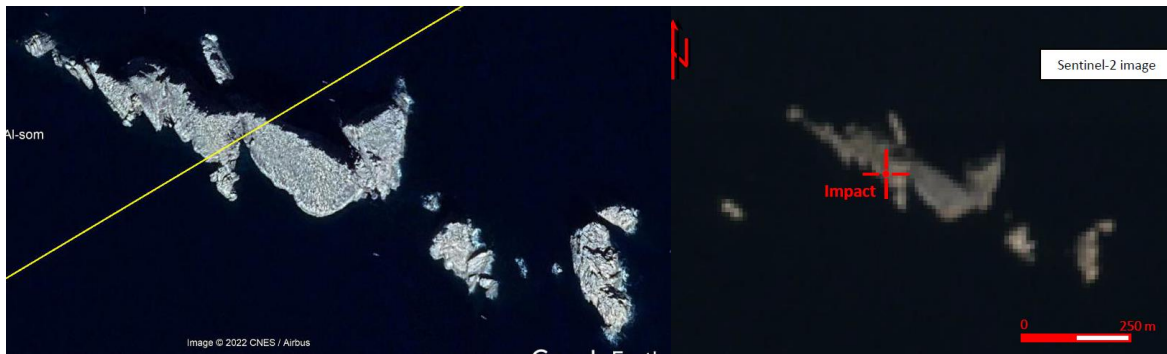

**KN-23 AXIS OF FIRING AND SUPPOSED IMPACT**

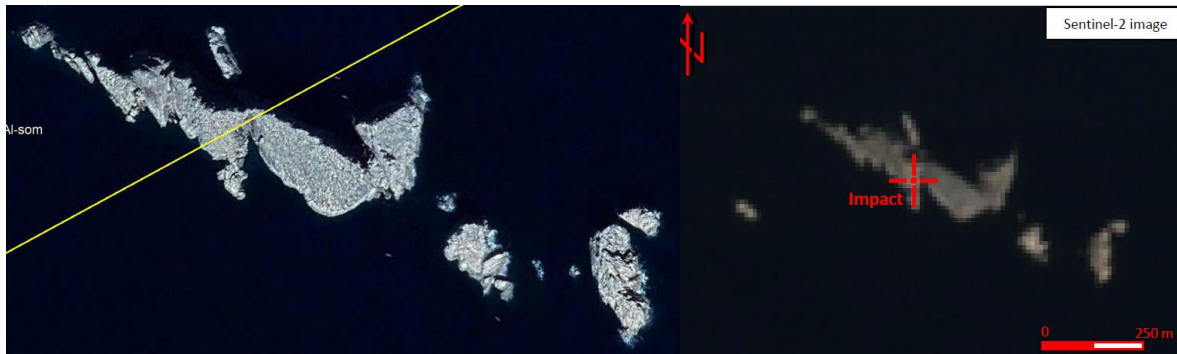

**KN-24 AXIS OF FIRING AND SUPPOSED IMPACT**

Source: GEO4i

These three firings were specifically employed in this study to assess the accuracy of the three types of missiles. It is important to note that an analysis of three firings, associated with three different missiles, does not allow us to draw any conclusions as to their performance. The conclusions drawn here are primarily indicative in nature and designed to assess the *possible accuracy* of the weapons.

Figure 44. Images probably showing the launch of a KN-25 on 1 August 2019

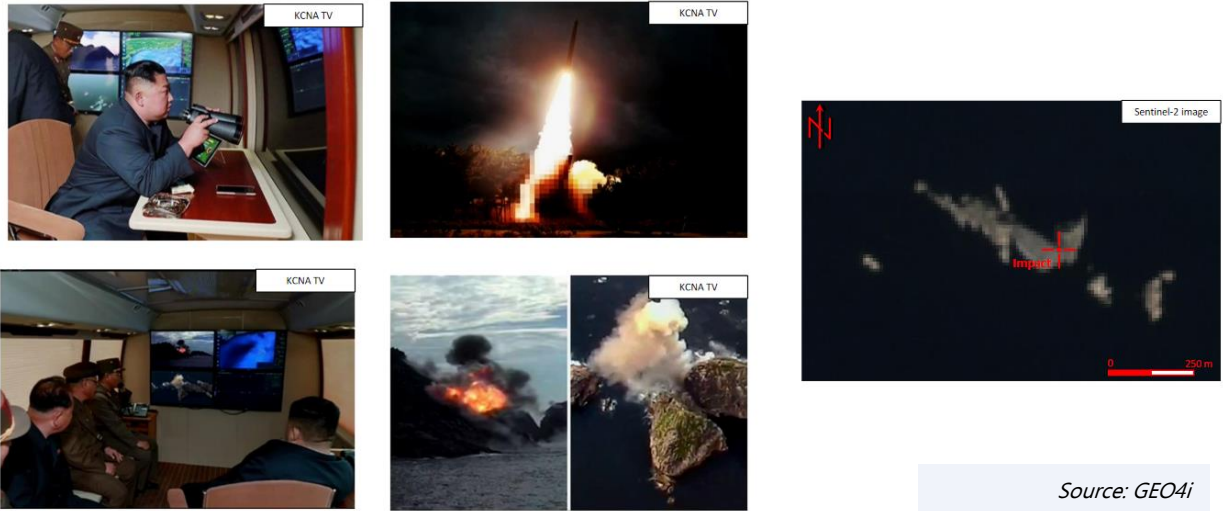

Source: GEO4i

Figure 45. Images of the launch of a KN-23 on 6 August 2019

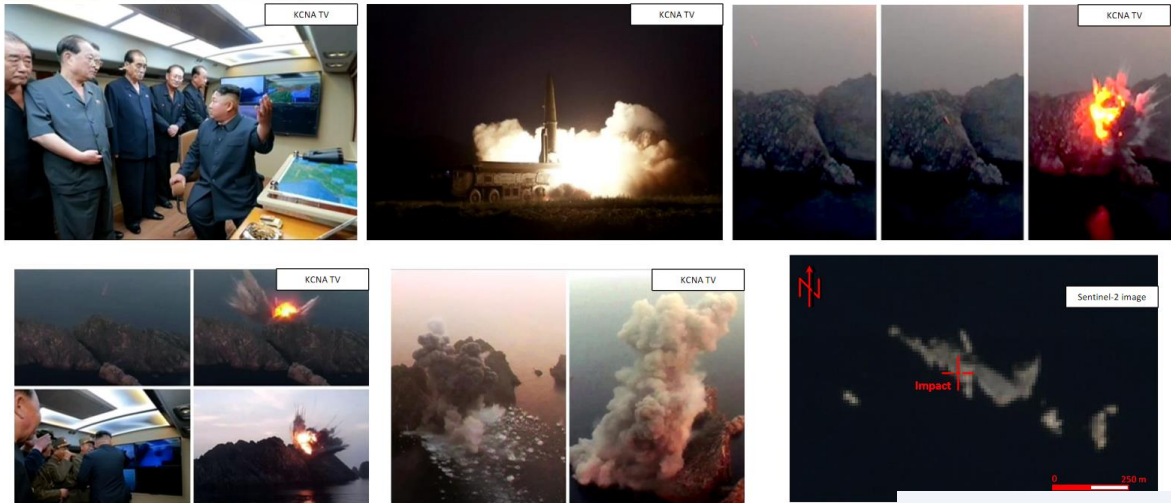

Source: GEO4i

Figure 46. Images of the launch of a KN-24 on 9 August 2019

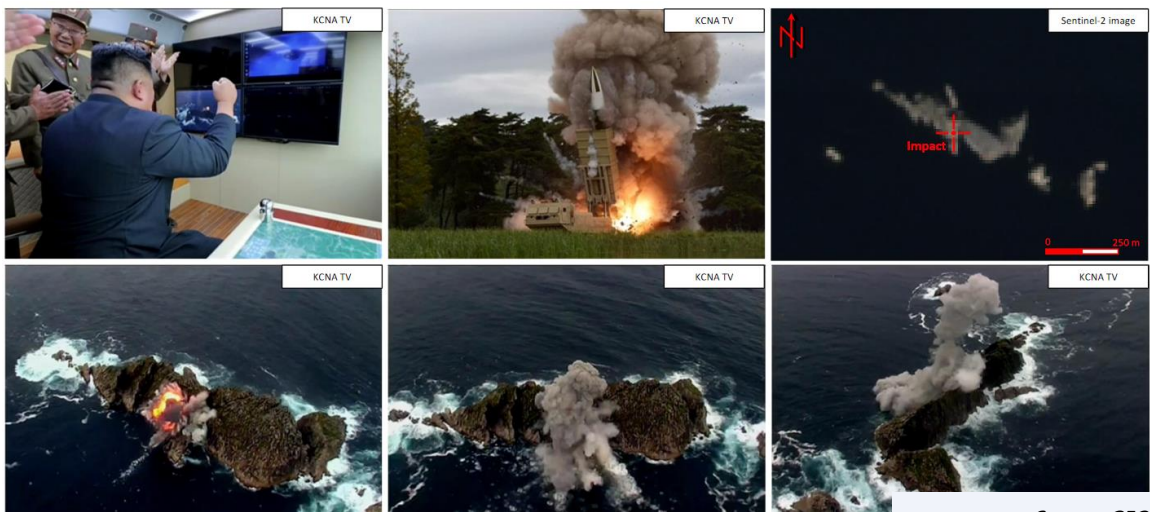

Source: GEO4i

Analysis of open-source radar satellite imagery analysis, including the development of a coherence map, adds further information. A coherence map is produced by juxtaposing radar images from two shots taken during a given time window. This makes it possible to identify whether an event took place during this period, but not to identify the exact date (unless the two images are very close together in time) or the exact nature of the event, since the image allows us to confirm only a change in the situation. Coherence maps were produced from the Sentinel-1 satellite constellation over the zone of the islet of Al-som. The period between the two images is 12 days (the periodicity with which the constellation passes over this zone). This allows for an assessment of whether an event took place during this timeframe and to situate it with relative precision. In the images below, it seems that the three firings associated with the published images correspond to events identified in time windows consistent with the date of the firings, respectively located approximately where the firings could be identified using the North Korean images. Since the islet is also used for other firing exercises, additional events may also be shown, which creates uncertainty on conclusions drawn.

Figure 47. Coherence map – Sentinel-1 analysis

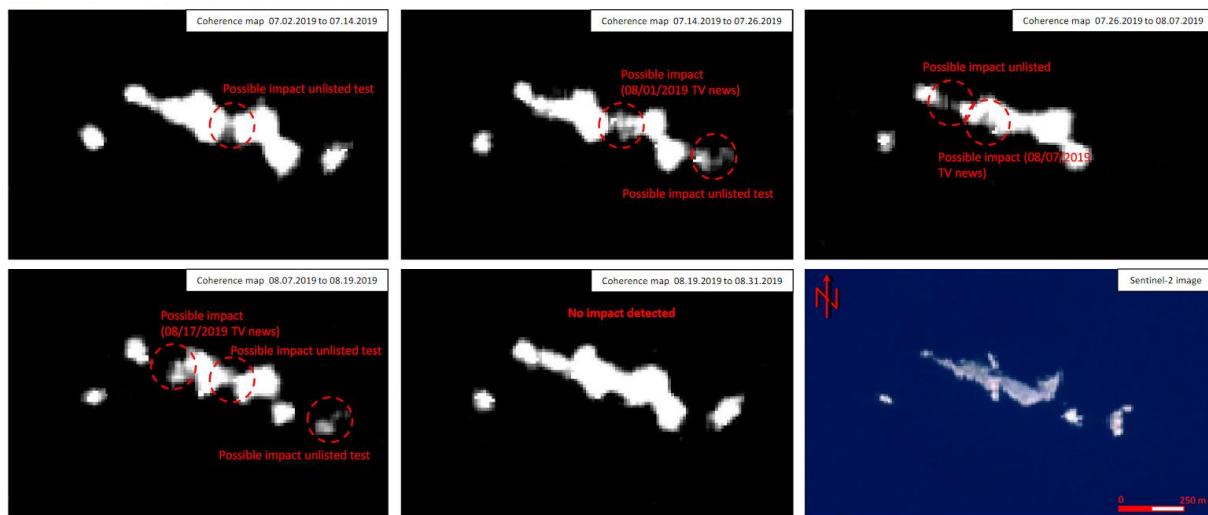

Source: GEO4i

The KN-25 impact showed on 1 August 2019 TV news is visible on coherence map 14 July 2019 to 26 July 2019, indicating that the test took place during this time slot.

The KN-23 impact showed on 7 August 2019 TV news is visible on coherence map 26 July 2019 to 7 August 2019, indicating that the test took place during this time slot.

The KN-24 impact showed on 17 August 2019 TV news is visible on coherence map 7 August to 19 August 2019, indicating that the test took place during this time slot.

It should be emphasised that if North Korea had decided to conceal the tests by having the firings coincide with detonations caused by other means than the missile, this could not be identified from the satellite analysis. In general, radar coherence maps are used in combination with other sources (such as optical imaging and electromagnetic information) which makes it possible to identify the factors that may have caused the alteration – a method that can only be applied to missile tests using telemetry data, that in these cases is not available through open sources. Therefore, although it cannot be said that the coherence map provides conclusive proof of the firings, it nevertheless tends to confirm the probability that the KN-23, KN-24 and possibly the KN-25 did indeed hit the islet of Al-som during the three series of tests of August 2019, and that a CEP estimate of around 35 m or less could be envisaged for the KN-23 and KN-24, and more hypothetically a CEP of 80–90 m for the KN-25.



## 5 Potential operational uses

---

The progressive transformation of the North Korean arsenal clearly has an operational impact, the nature of which depends upon North Korea's doctrinal stance on military operations, but also upon its political objectives. Although the intensity of the country's military effort and the increasing number of ballistic missile tests are generally taken as a clue to consider military operations and political objectives in maximalist terms, the gain in flexibility afforded by modernisation suggests other options to be considered that are more limited in intensity and duration, but nevertheless likely to significantly alter the political equilibrium on the peninsula, or even the balance of power between the protagonists. Only the short-term consequences of modernisation are considered here, since it is not yet possible to determine the extent to which Pyongyang will be able to completely overhaul its arsenal.

### 5.1 Maintaining a strategy based on the use of non-conventional munitions

#### 5.1.1 The contribution of new weapons systems

Assessing the potential role of a weapons system is always a delicate matter: its design, its characteristics and the architecture necessary for its implementation and operational use are all subject to a doctrinal framework that responds to specific strategic priorities and tactical constraints. The characteristics of a weapons system offer a finite set of options that limit its use; the effects it generates may have the aim of facilitating other military effects, or conversely of exploiting effects already generated by the use of other systems, in each case implying a different logic of use. Furthermore, use of the system must be consistent with the political stances taken by the authorities in the context of the use of force, but also with the doctrinal framework of the armed forces. Besides, tactical objectives linked to ballistic strikes are necessarily wide, leading to numerous options, both in terms of munitions used and target selection, to be defined. A strike will also be dependent upon the quality of the Command, Control, Communications, Computers, Intelligence, Surveillance and Reconnaissance (C4ISR) architecture in place, and therefore upon the ability of planners to identify priority targets – a task that becomes more complex as a conflict progresses. Finally, the performance of active defences and the characteristics of passive defences are key factors with a direct influence upon weapons use since they condition their effects.

As such, any analysis of North Korea's strike capabilities is subject to caveat, since the political and strategic frameworks that might lead to their actual use are still poorly understood, the doctrinal framework remains unclear, and numerous potential tactical options can be retained. However, the ability of North Korean officials to conduct strike operations over any sustained period of time remains severely limited by the estimated low resilience of their C4ISR architectures, the absolute air dominance that the United States and South Korea would achieve in the first few hours of a conflict, and the systematic risk of the rapid destruction of any identified strike system. These limitations may suggest that if North Korea chooses to go down a military path, its defined objectives would have to be achievable within a relatively short time frame. On the other hand, the emergence of an intercontinental strike capability and the development of a high-yield nuclear weapon, demonstrated by the Hwasong-15/KN-22 ICBM test and the nuclear test in September 2017, could mark a profound change in the strategy North Korea intends to adopt in the event of a crisis. The fact that Pyongyang is now capable of threatening US territory, at least in theory, could lead North Korean officials to reassess US willingness to engage and result in a logic of conflict management systematically backed by the threat of a strategic strike. This approach could see them downplaying the limitations of their short-range arsenal or, more

likely, anticipating a rapid transition from conventional and chemical operations to an explicit threat to cross the nuclear threshold.

Nevertheless, for North Korea, the development of a flexible conventional and non-conventional arsenal suitable for both crisis management and military escalation remains a priority. As demonstrated in the previous sections of this report, its current weapons systems are ill-adapted to any option other than either a demonstration strike or massive strikes. From this point of view, the development of the KN-23, KN-24 and KN-25 represents a significant evolution by giving the arsenal increased accuracy, penetration capability and range, but also the potential for graduated effects. These new systems should allow North Korea to consider the use of a broader spectrum of munitions with more discriminating effects than were possible with the previous generation of missiles. Detailed examination of the three missiles also suggests that they have been designed around particular operational specifications.

The KN-23 is the system best suited for deep strikes on Peninsula targets protected by missile defences. Given the complexity of this missile, its use might be expected to remain relatively rare and to be reserved for very specific missions such as the destruction of missile defences or C2 assets. With its heavier payload, the KN-23A could also be used in strikes against hardened targets (C2 or infrastructure). The range of both missiles enables them to cover very large areas of South Korean territory.

The KN-24 appears to have a different use profile. Like the MGM-140 (ATACMS), it could be used for saturation strikes against relatively deep military targets in the theatre of operation, the priority likely being missile defences and logistical concentrations. If the missile is produced in sufficient quantity, it could be used for strikes against air bases (such as runway strikes) or critical infrastructure.

Finally, the KN-25 tests suggest that it is probably regarded as a battlefield weapon, operating alongside KN-09s, and most likely primarily targeting artillery deployments, troop concentrations and military installations in tactically and operationally deep locations around and just beyond the demilitarised zone (DMZ), including tactical anti-aircraft and anti-missile systems, logistics nodes and second-echelon forces. Combined use of the KN-09 and the KN-25, capable of engaging South Korean artillery and hindering the manoeuvring of ground forces, is a fundamental element of North Korea's new force posture. It means that Pyongyang can envisage not only responding to a serious incident in the DMZ with a credible tactical escalation capability, but can also envisage a much more intense military operation.<sup>153</sup> Even if KN-09 and KN-25 are exposed to counter strikes (from the air but also from ATACMS and such systems), their range and mobility are valuable protections and may allow critical strikes against US and South Korean forces and infrastructures while South Korean and US troops are rallied. Moreover, like the KN-24, the KN-25 can be used for a wider range of missions once active defences have been neutralised, including against air bases, logistics nodes etc., with or without conventional munitions.

These three families of missiles give North Korea a coherent strike architecture, which appears to be organised in such a way as to allow the neutralisation of the elements that pose the greatest threat to its own force posture, namely missile defence systems, artillery deployments and logistics concentrations. All of these weapons seem to have been designed from the perspective of defence penetration, in the

---

<sup>153</sup> The importance of artillery-related concerns was reflected anecdotally in a statement by Kim Jong-un on 12 March 2020: 'Modern warfare is precisely the warfare of artillery pieces and the combat preparations of the artillerymen are exactly those of the People's Army'. See Koh Byung-joon, 'N.K. Leader Awaits Artillery Fire Competition,' *Yonhap News Agency*, 13 March 2020 (<https://en.yna.co.kr/view/AEN20200313000800325>), quoted in Xu Tianran, 'Analysis of the KN-25 Multiple Rocket Launcher System after the 9 March 2020 DPRK Test,' *Datayo*, 23 March 2020.

knowledge that eliminating some or all of these defences would enable North Korea to use its entire arsenal, including for non-conventional strikes. This is important since North Korea probably does not have sufficient propellant production capacity to allow mass production of all these missiles – especially since other programmes which are apparently a priority, such as the Pukguksong MRBM programme, could largely monopolise production capacity – and will therefore only be able to rely on conventional systems for a limited number of missions.

It is also likely that North Korean military officials expect partial or total disruption of GNSS access in the event of a conflict, leading to the assignment of more missiles armed with conventional munitions per target. Finally, certain types of targets suited for combat in chemical conditions, such as missile defences or hardened artillery positions, cannot be rapidly neutralised by chemical operations and may therefore be targeted primarily by conventional munitions. Therefore, while a conventional strike must be considered for limited operations, the new missiles currently deployed do not allow North Korea to fundamentally change its employment strategy in the event of a high-intensity conflict.

### **5.1.2 The role of missile modernisation in the context of chemical agent use**

The nature of the munition used for a strike is a fundamental factor in the assessment of any strike strategy. While a distinction is generally made between conventional and non-conventional munitions, and the latter are generally assessed on the basis of their nature (nuclear, chemical or biological), the operational uses of weapons of mass destruction (WMD) can be closely related to the nature and characteristics of the delivery vehicle. Developments in the delivery system can therefore affect the doctrine of employment.

Unlike conventional weapons, WMDs generate a *political* effect by virtue of their very existence. The *intensity* of the political effect, however, depends upon the ability of the state that has them to operationalise these weapons, but also to develop credible options for their use, in particular through the graduation of their effects. The focus on graduated effects creates a close relationship between the characteristics of the delivery vehicle (essentially its accuracy, range and defence penetration capability) and the characteristics of the non-conventional munition (the yield of the warhead, for nuclear weapons, and the mass and type of the dispersed agents for chemical and bacteriological weapons). The successful development of an accurate missile therefore does not mean that the doctrine of use excludes the use of WMD, since the accuracy of the missile and its coupling to a WMD in limited operations are factors in making the threat of use credible. In military terms also, the ability to control the effects of WMD is an important factor in generating vulnerabilities in the opposing forces, hindering the opponent's deployment, operations and ability to escalate.

Given the major role assessed to be played by chemical weapons in North Korea's arsenal, it is important to consider the considerable contribution that more accurate missiles could make to the strike strategy. While the low accuracy of the Scud B and Scud C made it difficult for North Korea to consider striking deep military targets, at least in the framework of a 'limited' operation, the forthcoming deployment of the KN-23, KN-24 and KN-25 could be a game changer. Even if it is estimated that a 500 kg VX payload (which is approximately the load of VX in a Scud B warhead) dispersed by a missile could theoretically

cover an area 3 km long and 300 m wide,<sup>154</sup> the exposure of a military base is obviously very different if the missile has a circular error probable (CEP) of 600 to 900 m than if it has a CEP of 30 to 60 m. Taking the Osan Air Base as an example, a schematic representation of an attack carried out in a north-easterly wind under optimal conditions (clear weather, low wind speed and at night) shows that North Korea at the lower CEPs could probably target areas of interest with a high level of confidence. In this example, a strike would target the hangars in the north-eastern zone which house cargo planes and U2s, much of the support infrastructure and some of the barracks. Three to four missiles at the lower CEPs would hit almost all vital areas of the base, i.e. the command areas of the various units to the east, the four dispersal areas in the centre of the base, the support area, the barracks area, the PAC-3 deployment area and the ammunition stockpile.

This example can of course be replicated for major logistics centres such as Camp Humphreys, and for more specific areas such as artillery deployment zones. Any of the missiles currently being developed by North Korea could be used for this type of mission, since they all have the necessary range, payload and, potentially, accuracy.

*Figure 48. Theoretical coverage area of 500 kg of VX under optimal conditions at Osan Air Base, north-east dispersion axis*



Source: Google Earth

Aside from the flexibility afforded by the accuracy of the delivery systems and their penetration capability, the hypothesis of operational use of chemical weapons must be considered in relation to the

<sup>154</sup> See Brian G. Chow, Gregory S. Jones, Irving Lachow, John Stillion, Dean Wilkering, and Howell Yee, *Air Force Operations in a Chemical and Biological Environment*, Documented Briefing, RAND Corporation, 1998, [https://www.rand.org/content/dam/rand/pubs/documented\\_briefings/2007/DB189.1.pdf](https://www.rand.org/content/dam/rand/pubs/documented_briefings/2007/DB189.1.pdf), and Steve Zaloga, op. cit.

development of North Korea's strategic nuclear strike capability, but also in relation to the possible development of a tactical nuclear strike capability. Whereas until now the use of chemical weapons was likely to expose Pyongyang to nuclear retaliation by the United States, the probability of such retaliation is necessarily reduced by the fact that a nuclear response to a chemical attack could provoke a nuclear counter-strike against the US homeland by North Korea. Thus, in addition to the operational benefits of using toxic agents on air bases, logistics centres and critical industrial infrastructure, there is an additional psychological dimension. US and South Korean forces must anticipate the fact that North Korea may no longer view the use of these weapons as a potentially suicidal escalation, but rather as a means of controlled escalation that not only hinders the opposing military effort but also sends a strong signal of Pyongyang's readiness to commit to extreme escalation.

## 5.2 Conventional strike options as part of a coercive strategy

Clearly, the gradual expansion of options for WMD-coupled strikes does not preclude the use of the missiles under development for conventional strike purposes. It is hardly conceivable that North Korea would re-centre its strike strategy around a predominantly conventional logic in the event of a major conflict, this kind of strategy requiring considerable amount of ammunition. However, the possibility of this option being taken in the context of coercive or limited conflict strikes must be considered.

While relatively rudimentary C4ISR may be sufficient to carry out tactical and deep strikes against infrastructure in the initial phase of a conflict, maintaining a conventional strike strategy over time requires a minimum capability to assess military activity at target sites and to discriminate targets of interest. It may be hypothesised that North Korea would attempt to strike critical sites several times, such as major air base runways, in order to generate extended paralysis, on the assumption that use of this infrastructure would be crucial for US and South Korean forces to maintain the tempo of their operations. Engagement of mobile weapons systems (PAC-3 or KM-SAM missile defence systems) or logistics points would, however, be far more challenging once US and South Korean forces left their peacetime stationing areas. At the same time, assuming that the stockpile of weapons capable of precision strikes may remain relatively small in the coming years, the limitations of the existing arsenal are unlikely to change. As most of the operational missiles (i.e. Scud B and C) have only marginal military utility – including for the use of chemical weapons – Pyongyang may view most potential military operations from the perspective of a 'political strike', aiming more at political concession through military operation than at a military victory *per se*. In this sense, the most significant immediate impact of the modernisation of the arsenal is likely to be felt in the context of limited operations, in which North Korea threatens South Korea or carries out strikes on a number of high-value or symbolic targets (including in military terms) in order to achieve political gain.

Some analysts have demonstrated that the existence of heavy artillery concentrations along the DMZ, along with the introduction of systems such as the KN-09,<sup>155</sup> could open up conventional options for limited or massive bombardment of economic or population targets in the Incheon-Seoul area. These assessments consistently yield relatively high casualty estimates owing to the imprecision of the weapon

---

<sup>155</sup> D. Sean Barnett, Yvonne K. Crane, Gian Gentile, Timothy M. Bonds, Dan Madden, and Katherine Pfrommer, *North Korean Conventional Artillery: A Means to Retaliate, Coerce, Deter, or Terrorize Populations*, Arroyo Center, RAND Corporation, 2020 and Peter D. Zimmerman, 'Assessing the DPRK's KN-09 300 Mm Multiple Rocket Launcher System: Decisive or Incremental?', *NAPSNet Special Reports*, 10 June 2018, <https://nautilus.org/napsnet/napsnet-special-reports/assessing-the-dprks-kn-09-300-mm-multiple-rocket-launcher-system-decisive-or-incremental/>.

systems and the large number of strikes required to ensure an effect. A number of recent historical examples show that the military management of a crisis is above all correlated with the identification of vulnerabilities in the opposing force posture and with a demonstration that the absence of a rapid political solution is likely to lead to more damaging strikes. Therefore, while the vulnerabilities posed by the accumulation of artillery assets along the DMZ are real, and enable North Korea to envisage conventional options, the acquisition of quasi-ballistic precision capabilities is a fundamental breakthrough that opens up a very wide range of coercive options for North Korea.

If it is assumed that Pyongyang would consider the use of force within a strategy of limited strikes, and would seek to combine the use of a very low number of weapons with the production of maximum symbolic, economic, political or military effect, the accuracy of the weapons and their defence penetration capability represent two fundamental parameters.

A weapon with a CEP of 30 to 60 m and a payload of around 500–1500 kg can be expected to generate a significant military effect with the use of conventional munitions. Depending on the effectiveness of the defences and the type of target, it may only take a few missiles to neutralise a specific target. The complete neutralisation of a major military infrastructure would, on the other hand, require a far higher volume of missiles and would seem to be ruled out of a coercive scenario. At the same time, given the density of defences in South Korea's critical economic zones, especially the Incheon-Seoul-Pyeongtaek area, penetration capability is a determining factor, in both strictly military and political terms, as demonstrating a strike capability in spite of the existence of defences would illustrate the uselessness of these defences and South Korea's vulnerability to attack. Furthermore, given the range of the KN-23 systems, targeting the economic or military zones in the south of the peninsula, which are largely defended by systems unsuited to the interception of quasi-ballistic missiles (THAAD and SM-3) remains a perfectly conceivable option (for example, the industrial complexes of Pusan, Ulsan and Pohang, and the Gimhae Air Base, which houses the E-7 AWACS, KC-330 refuelling tankers and some of South Korea's C-130 transport aircraft). In the long term, however, we can assume that these areas will be defended with more suitable systems and that quasi-ballistic missiles will be more vulnerable to interception, since the terminal velocity of the weapons is lower at long range and defence systems have more opportunities to engage them.

It is important to emphasise that in relation to the current balance of power between the protagonists, the most tangible benefit to North Korea of upgrading its arsenal therefore concerns the coercive phase of crisis management. This phase is initiated by the decision of one of the protagonists to move from political and military pressure to an actual strike, in a situation where its opponent is not politically able to pre-empt the strike and the dispersal of its forces is perceived in itself as an aggravating factor of the crisis. North Korea would also have the capability to disperse some of its forces before an operation without triggering an alert in South Korea but may also choose to replicate the Russian *modus operandi* applied in Ukraine and multiply dispersion, military drills and outspoken military provocations over a number of years to lower the mobilisation of its opponent before launching a limited attack.

In this kind of situation, the aggressor has real flexibility in its choice of both military and civilian targets, and can count on maximum effects. Although economic sites appear to be potentially more vulnerable than military ones, the latter are nonetheless potential targets. In the following examples, which are by no means exhaustive, we present different options for economic coercive strikes, briefly consider political coercive strikes, and assess a few possibilities for limited strikes against military equipment or infrastructure.

## 5.2.1 Economic coercive strikes

Economic targets are the classic targets for a coercive strike, as they are generally vulnerable and may be of high symbolic value. The after-effects of neutralisation vary depending on the type of infrastructure targeted, from impacting on citizens and the economy (neutralisation of energy infrastructure) to generating long-term effects (neutralisation of infrastructure related to the export of key products or raw materials, and infrastructure related to the processing of raw materials or use of resources). Although the industrial areas of Seoul and Incheon are exposed to North Korean artillery, and North Korea is capable of carrying out a short but high-intensity strike from protected positions without exposing itself to a counter-strike from South Korean artillery,<sup>156</sup> a ballistic missile strike would appear to be more advantageous.

A recent study by RAND<sup>157</sup> highlights the undeniable danger posed by North Korea's artillery in the context of an economic demonstration strike. Taking as a case study the LG P-10 factory (one of the world's major production centres of LED/OLED technologies), which is located in the suburb of Paju, around 10 km from the DMZ and 20 km from the positions of the North Korean II Army Corps, the report shows that six 152 mm howitzers and six 122 mm multiple rocket launchers firing 210 projectiles over a period of 5 minutes would be enough to destroy the site. However, the report's choice of this target illustrates the constraints on using artillery in such a scenario. The report places the engagement distance of North Korean weapons at their maximum range (20 km for 122 mm rockets and 24 km for 152 mm artillery). At this range, the dispersion of munitions would be in excess of several hundred metres. The effectiveness of the strike would therefore be directly linked to the size of the target site. In this case, the two main groups of buildings are about 500 and 680 m long and 180 to 250 m wide. The inaccuracy of artillery assets fired at maximum range thus greatly reduces the types of potential target site available to North Korea, short of proceeding to more massive or extended strikes. The duration of the strike is also a significant tactical problem: in the example set out by RAND, which represents an ideal case, a sustained bombardment of more than 5 minutes would allow South Korean artillery to accurately identify firing zones and engage in a counter-strike, risking an escalation that would be difficult to control. The dense deployment of South Korean artillery systems along the DMZ, based around self-propelled systems operating mostly from protected or hardened sites, makes a North Korean political strike against infrastructure or even against a population centre more unlikely, as the South Korean forces are sufficiently numerous and their weapons systems sufficiently modern to inflict significant losses on North Korean forces.

The missiles and heavy guided rockets recently developed by North Korea offer a far greater range of options against this type of infrastructure. Firing just a few weapons could be enough to severely damage production for a sustained period of time with a reduced likelihood of effective counterbattery strikes by South Korea. By firing from several hundred kilometres away from the target, North Korea would be able to reduce the risk of the firing zones being identified by existing South Korean assets, which would have to rely on US data to give an accurate location, knowing that the non-ballistic flight of the KN-23 and the KN-24 may even prevent it. This would reduce the likelihood of a rapid counter-strike, which would need to involve aircraft or long-range missiles that may require political approval to engage. While reprisal would be very likely, South Korea may not be able to build a 'tit for tat' strategy allowing the immediate destruction of the enemy firing weapons, an option that is conceivable against short-

---

<sup>156</sup> See Michael O'Hanlon, 'Stopping a North Korean Invasion: Why Defending South Korea is Easier Than the Pentagon Thinks,' *International Security*, vol. 22, n°4, 1998.

<sup>157</sup> Barnett et al., *North Korean Conventional Artillery*, op. cit.

range artillery, and that is probably easier to map out politically than deep strikes into North Korea. Last but certainly not least, the accuracy of the missiles and their military payload would allow the strike to be extended to any type of similar or smaller industrial infrastructure in the deepest part of South Korean territory. For example, Samsung’s four major semiconductor and integrated circuit production sites, located more than 70 km from the DMZ, represent very high-value potential targets for an economic coercive strike. Located within an area heavily defended by South Korean and US missile defences, these sites currently have little vulnerability to a potential strike by any of the weapons in North Korea’s existing missile arsenal. Conversely, KN-23 or KN-24 missiles, fired from over 200 km inside North Korean territory, would be far more difficult to intercept, especially since the terminal velocity of the weapons would remain relatively high at these distances. If such infrastructure were struck with a KN-23A missile, equipped with a ground penetrator, the missile would likely penetrate deep into the buildings, maximising the destructive effect. Samsung’s four production sites, positioned between 70 and 130 km from the DMZ, would all be under potential threat from such strikes.

*Figure 49. Hypothetical representation of strikes on the Giheung semiconductor production site by a weapon with a CEP of 30 m (yellow circle) or 60 m (red circle), representative of the possible accuracy of the KN-23 and KN-24 missiles*

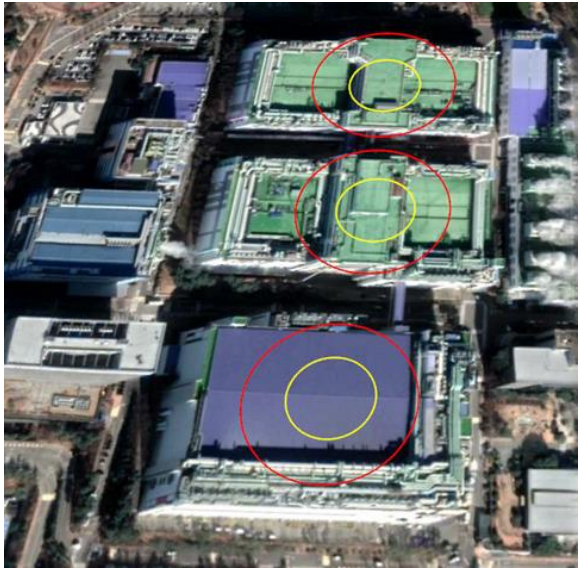

*Source: Google Earth*

The inherent advantage of precision strike capabilities is made much clearer, however, if we put a potential economic coercive strike into a wider context. In this type of scenario, the aggressor is usually aiming to generate maximum economic effect, rather than to cause loss of life. The objective of the strike may be to halt production without necessarily destroying the production site.

Returning to RAND’s example of the P10 plant in Paju, this type of approach might suggest targeting the site’s power supply. The most obvious vulnerabilities in an electricity network concern the transformers – at the output of power stations or at the input of large industrial sites, power lines and technical buildings linked to power flow management.

At the P10 plant a high-voltage line runs to a distribution substation and a transformer, making it potentially vulnerable to strikes by missiles with CEPs of 30–60 m. As shown in Figure 5 (see Part. 2.3.1), overpressure of approximately 34–69 KPa (5–10 psi) would be generated by the detonation of 545 kg of explosive at 15 m altitude, over distances between 30–40 m. Such overpressure would be more than sufficient to destroy transformers and power lines, but would also significantly damage insufficiently hardened buildings. With CEPs of up to 60 m, the use of submunitions also offers considerable advantages against non-hardened targets, especially transformers. Cutting off the power supply to the P10 plant without the risk of inflicting heavy casualties is therefore feasible, and the risk of escalation is less than if the site had to be razed by an artillery strike.



Figure 50. Vulnerabilities on the incoming power grid of the Paju P10 plant for a weapon with a CEP of around 30 m – Electric Switch Yard, Kyonggi Area, 37°48'21"N, 126°46'05"E

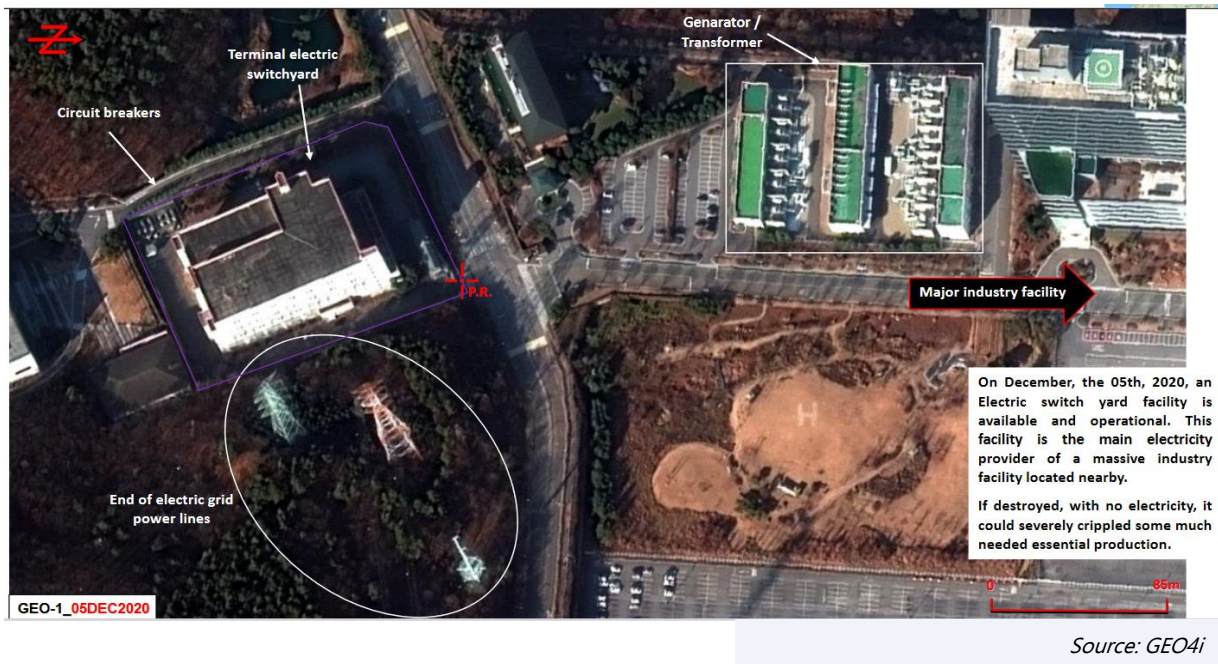

As noted above, the threat of vulnerable elements of a power grid being destroyed is not new, but was previously limited to infrastructure within 20 km of the DMZ, as North Korea’s current ballistic missiles do not allow for destruction other than by a massive strike. The gradual development of the KN-09 heavy multiple rocket has extended the threat to a greater depth, with the 200 km range of the weapon covering the Incheon-Seoul-Pyeongtaek area. However, the KN-23, 24 and 25 provide a different strike capability, allowing for substantial destructive effect with fewer weapons, greater flexibility in the choice of payloads, and reduced exposure to defences given their flight profiles. Meanwhile, the longer ranges of these weapons allow the entire peninsula to be reached from firing points located relatively deep in North Korean territory.

Targeting the power grid represents a vulnerability that could be systematically exploited by North Korea, as a strike on transformers could be sufficient to generate major power disruption but could also cause cascade effects if several points in the network are destroyed. Ensuring a sustained blackout across the Seoul-Incheon region would, however, require a strike of a different magnitude, as the area’s power is supplied by a dense network of power plants and substations. The map below shows an overview of the power plants and substations serving the area. Neutralising the distribution capacity of the major power plants would require the destruction of two or three zones on average (depending on the number of generation units) taking into account only the transformers, while it would be imperative to destroy a number of substations in order to prevent the relatively rapid recovery of distribution capacity. Although the destruction of network elements is feasible in a logic of limited strikes, organising a massive strike designed to permanently interrupt electricity distribution in the region would imply a high-intensity engagement.

Figure 51. Power plants (yellow circles) and substations (blue circles) that distribute electricity to the Seoul, Daejeon, and Pyeongtaek region

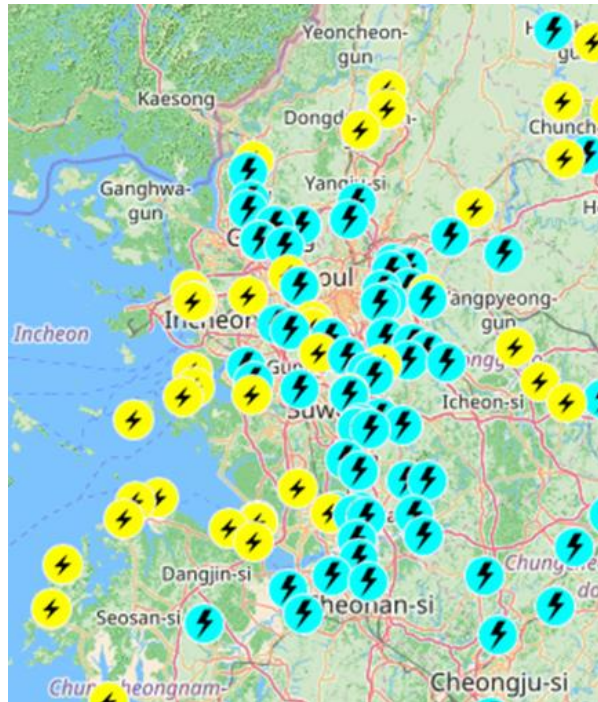

Source: GEO4i

The range of infrastructure that could be affected by an economic coercive strike is clearly very broad. Among other potential targets, oil refineries are of obvious interest. Immediately reducing fuel consumption in South Korea would, however, be impossible without targeting stocks. Even if the storage facility of only a single refinery were targeted, the strike would have to be an especially large one. Numerous other targets could be mentioned, but their detailed study lies beyond the scope of this report.

## 5.2.2 Strikes against centres of power or major administrative infrastructure

Ballistic missile strikes are often associated with political decapitation strikes, usually in conjunction with nuclear weapons. Conventional strikes are also, however, a possibility, aiming less to destroy the South's ruling elites than to demonstrate Seoul's vulnerability. Yet given the limitations of conventional munitions with respect to deeply buried and hardened targets, which in a crisis can ensure the continuity of essential political and administrative functions, it is unlikely that decapitation strikes could be carried out with conventional systems – unless, once again, to take advantage of strategic surprise by initiating conflict in a sudden and unexpected manner.

This does not mean that strikes against C2-related infrastructure are inconceivable, especially if an earth penetrator is developed for the KN-23A. Such strikes could target buildings associated with decision-making or command bodies, but presumably would be part of an overt conflict rather than a limited political strike. Symbolically, however, Seoul is highly vulnerable to a precision strike, with buildings of high political value such as the Blue House and the National Assembly now directly exposed.

This does not mean that strikes against C2-related infrastructure are inconceivable, especially if an earth penetrator is developed for the KN-23A. Such strikes could target buildings associated with decision-making or command bodies, but presumably would be part of an overt conflict rather than a limited political strike. Symbolically, however, Seoul is highly vulnerable to a precision strike, with buildings of high political value such as the Blue House and the National Assembly now directly exposed.

### **5.2.3 Strikes on military targets for political coercive purposes**

Historically, the use of military assets for political coercion has almost always been associated with strikes on military targets (air bases, training centres and more rarely barracks) or industrial targets closely linked to military operations. At a more tactical level, coercive strikes may target facilities or forces (artillery positions and tactical C2) directly involved in a military incident. North and South Korea have already been engaged in such exchanges of fire, most notably in 2010 during the bombardment of Yeonpyeong Island.

This strategy makes it possible to justify military retaliation without declaring war, with the openly stated aim of exerting military pressure. This policy has been commonly adopted by the West since 1991, and has for some years now been adopted by Iran, which in this respect offers a good example of the policies that proliferating states may adopt. Iran is moreover remarkable for its regular use of ballistic missiles, particularly for interdiction strikes against hostile militias, but also for decapitation strikes against the leaders of those movements. The attack on the US Al Asad air base on 8 January 2020 also invites conceptual comparison with the logic of Western coercive strikes, Tehran having deliberately targeted the base in retaliation for the operation carried out by the United States against General Soleimani a few days earlier. This operation also demonstrates that a coercive strike against the military infrastructure of a major power or one of its direct allies is a possibility.

Such operations usually take place in a context of high tension, but not so high that armed units potentially exposed to military operation will have been dispersed, which thus leaves such units vulnerable to attack. Although the Al Asad example shows that US intelligence was able to detect the preparation of the attack, enabling the most mobile equipment and personnel to be evacuated or sheltered, the challenges are obviously very different where potential targets are far more numerous, as in South Korea.

The vulnerability of US and South Korean forces and infrastructure is difficult to assess. It depends as much on the defences as on the dispersal measures taken at the time of the strike and, in the case of infrastructure, on their hardening. The exact accuracy of North Korean missiles also remains unknown, notably in the event of GNSS signal interruption or jamming. However, it is likely that North Korea is conducting some of its tests with systems partially decoupled from GNSS signals, in order to assess the accuracy of its weapons when jammed. The resulting loss of accuracy may prompt the planner to select targets according to their vulnerability, leading, for example, to a focus on targets vulnerable to area effect munitions (submunitions and fuel-air explosives (FAE)). At short ranges the reduction in accuracy may also be marginal enough to allow viable strikes on infrastructure.

Finally, in all of these cases, defence penetration capability remains a crucial variable. As it stands, there are no available open-source data from which to extrapolate the performance of the terminal defences (PAC-3 and Cheolmae II) against quasi-ballistic missiles. It is also impossible to estimate the extent to which the probability of interception will be increased by the deployment of the IBCS architecture currently being implemented by the United States (see note 119). Assuming a strike on the

Incheon/Seoul/Pyeongtaek region, it is very likely that North Korea would plan its strikes to maximise the missile's velocity, favouring firing from relatively short-range without use of a skipping manoeuvre. Firing at about 50 km from the DMZ would allow the entire area to be covered with flight distances of 200–250 km, allowing low-apogee flights (about 30–40 km) and high terminal velocities to be maintained. On this assumption, the missile would probably retain enough energy to perform a terminal manoeuvre along with evasive manoeuvres during flight, if North Korean missiles have such a capability. This combination of manoeuvrability and speed could drastically limit the possibility of interception. The military targets adjacent to the DMZ are less heavily protected by active defences and open sources do not provide data enabling us to assess the extent to which the navigation and guidance systems of North Korean heavy rockets and missiles could be jammed. They could therefore ultimately be targets for precision strikes.

#### **5.2.4 Tactical strikes against South Korean artillery positions**

In the absence of active defences, hardening and the dispersal of forces to hardened positions are effective ways to protect against artillery and ballistic missile strikes. Over the past decade, South Korea has invested heavily in hardening the artillery positions that line the DMZ to a depth of around 30 km. This infrastructure modernisation is not only the result of the developing ballistic missile threat. One of the most crucial phases of a conflict would consist of ensuring fire dominance across the DMZ in order to block the penetration of opposing forces and to ensure continued manoeuvrability of one's own forces. North Korea's immense vulnerability to precision air strikes means that Pyongyang cannot countenance a long-term artillery duel. It therefore needs to develop the means to rapidly neutralise its opponent's assets.

Although North Korea boasts a considerable numerical advantage, South Korea has absolute qualitative superiority. The bulk of its artillery system is based on self-propelled K-9 guns with a high rate of fire and a rapid reloading capability. In addition to the performance of the weapons system, the use of self-propelled artillery also enables better exploitation of hardened positions. It can operate under cover and quickly relocate to prepared positions, reducing its vulnerability to counter-strikes and allowing it to continue operations in degraded – including chemically degraded – environments. South Korea's extensive hardening programme has thus greatly reduced its potential vulnerability, in particular to North Korea's artillery, but also to KN-02 SRBMs.

Figure 52. Example of a high-capacity hardened position – North Kyonggi Area – 37°49'43"N, 126°44'58"E

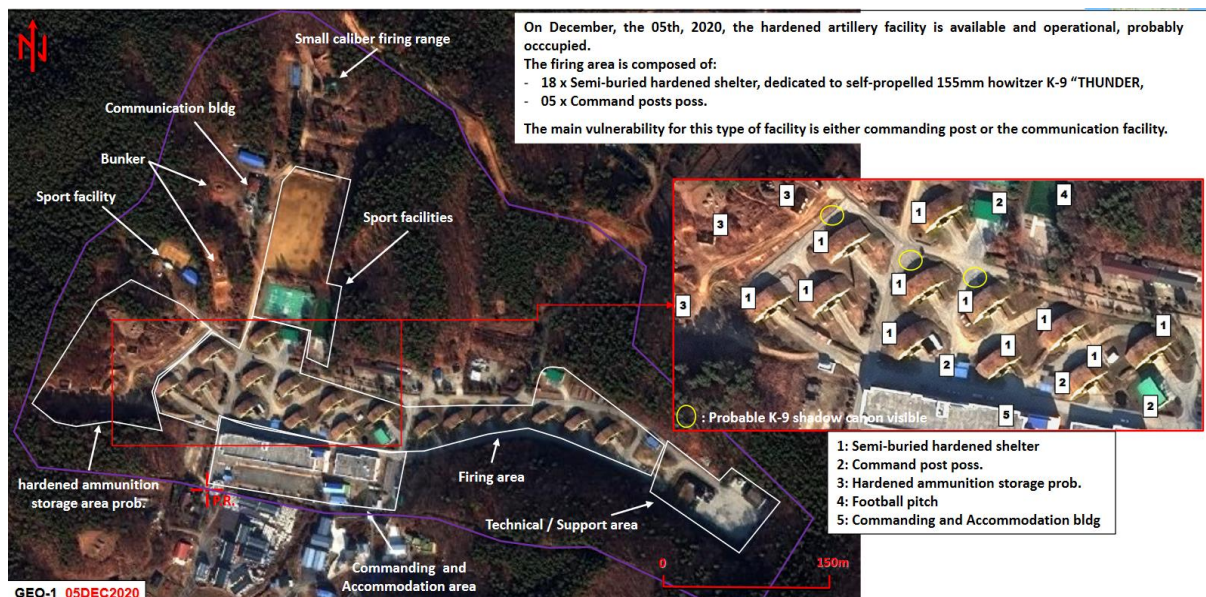

Source: GEO4i

Given the dispersion of artillery ammunition fired at nominal range (15–25 km in general, 30–40 km for 122 mm rockets and rocket-assisted shells), neutralising this type of infrastructure by even massive bombardment is time-consuming, unless a maximum of firepower is concentrated against a limited number of targets. However, the density of the South Korean deployment is such that this tactic would expose North Korean units to immediate counter-strike. The increase in the number of South Korea’s multiple rocket launchers would also rapidly expose North Korean towed artillery units to massive counter-strikes in the event of a phase of sustained fire.

This fortification of defences makes it very difficult for North Korea to envisage the use of artillery in the DMZ for coercive operations with its conventional means alone. In this respect the KN-09 and KN-25 systems are likely to have a substantial impact. The former would allow a saturation strike on a given target in a few minutes, while the latter is (potentially) sufficiently precise for a strike against individual targets with either unitary or cluster/FAE munitions. Although the CEP of the weapon is insufficient to guarantee the destruction of individual bunkers in one strike, salvo attacks could statistically result in the destruction of some of the targets, potentially forcing the targeted units to withdraw.

It is difficult to provide a precise assessment of the current exposure of the South Korean hardened artillery deployment areas. It is, however, clear that the existence of heavy strike assets capable of targeting them with a reduced possibility effective counter-strikes creates potential vulnerabilities that North Korea might be tempted to exploit and that South Korea’s political and military leaders cannot ignore. In addition to the development of ever more effective counter-strike capabilities – an option that South Korea continues to develop – part of the solution is likely to lie in the further deployment of active defences.

## 5.2.5 Strikes against missile defence units and architecture

Somewhat paradoxically, missile defences are currently one of the elements potentially vulnerable to attack, especially if North Korea were to focus its strikes on systems whose coverage has low redundancy, on the edge of the DMZ or, conversely, deeper into the peninsula. Attacking these systems offers two distinct advantages: politically, eliminating them would be a demonstration of vulnerability; and militarily, it would help erode the performance of the defensive architecture and may make possible the subsequent use of older components of the arsenal that are more vulnerable to interception.

It is likely that the point missile defences (Cheolmae II) deployed by South Korea to cover its artillery positions would be targeted. On the assumption that these systems would not have been redeployed, they represent particularly vulnerable targets, lacking sufficient interception capability to mitigate the effects of salvo attacks and possibly unable to adapt to the very low trajectories of the KN-25. Unlike the PAC-3s, however, these systems are highly mobile and could therefore easily be relocated to combat positions, on short notice. North Korea's lack of intelligence, surveillance and reconnaissance (ISR) capability would allow Cheolmae II units to operate with less risk, even though the proliferation of reconnaissance drones poses a tangible threat as they can relay information to fire units in real time.

US and South Korean missile defence radars, meanwhile, present certain vulnerabilities due to their specific technical features. These are more evident for the PAC-3, THAAD, and Green Pine systems, which are either designed as mobile systems (PAC-3) that are deployed as static defences, or designed as transportable systems which, once deployed, lose all mobility (THAAD and Green Pine radar). In the case of the PAC-3s, the principal vulnerability concerns the requirement that the missile batteries and the radar be concentrated in a relatively small area. The system remains mobile, however, and could be moved, and the modernisation of the PAC-3 system and the implementation of IBCS should limit this vulnerability in the relatively near future, by allowing the firing units and the radar to be deployed at a safer distance apart and, in the event of the battery radar being destroyed, to reorganise it around the radars of other batteries.

In addition to the PAC-3s, the two Green Pine early warning radars and the THAAD battery remain potential targets, as they represent vulnerable elements with very high added value. Both systems play a key role in detecting and tracking ballistic missiles and, in the case of the THAADs, are highly effective at intercepting them. Low-apogee launches of quasi-ballistic missiles can be identified by the Green Pine and the THAAD radar,<sup>158</sup> which are able to track the entire trajectory of the missile as soon as the boost phase is over. Since the sensors of the PAC-3 and Cheolmae systems are still very limited in relation to quasi-ballistic missiles, the Green Pine and THAAD radar directly help to improve the quality of radar tracking and thus increase the probability of interception. Finally, as part of the United States' IBCS programme, THAAD is to be progressively upgraded to combine its trajectory data with that of the PAC-3s, whose radars are themselves capable of pooling their respective data.<sup>159</sup> These are essential capabilities for increasing the probability of quasi-ballistic missiles being intercepted.

---

<sup>158</sup> On the issue of THAAD detection, see for example the very illuminating article by Michael Elleman, 'North Korea's Short-Range Ballistic Missiles: They Can't "Evade Detection" and are Still Vulnerable to Interception', *38 North*, 2 October 2020, <https://www.38north.org/2020/10/melleman100220/>.

<sup>159</sup> THAADs can also share trajectory data with the SPY-1 radars deployed on US Aegis ships.

Figure 53. MIM-140 Patriot PAC-3 ADS/ABM battery at Osan Air Base, 37°04'36"N, 127°16'06"E



Figure 54. Deployment of the Jincheong-Gun region Green Pine ABM radar, Jincheon-gun, 36°50'29"N, 127°24'23"E



Figure 55. THAAD deployment from the Seongju area, Lotte Skyhill Seongju Country Club Facility, 36°02'44"N, 128°13'24"E



Source: GEO4i

However, THAAD and Green Pine were designed as deep defence systems under minimal risk of being targeted by strikes. The THAAD radar, which is transportable but not mobile, and the organisation of the battery, which requires the radar and firing units to be located at the same site, both represent vulnerabilities. Weapons with a medium CEP – of around 100 m – may be sufficient to neutralise them, as the antennae, fire control systems, and power units, but also fire units,<sup>160</sup> are highly vulnerable and insufficiently armoured against submunitions. The Green Pines are also static and the protective radomes that cover them would probably be insufficient to protect the antennae.

As emphasised above, the scale of the defences (active and passive) almost necessarily excludes any strike on an air base in the Incheon-Seoul-Pyeongtaek area (such as Osan, Suwon, Seosan and Seongnam) in the context of a limited scenario. While a demonstration strike can be envisaged, any attempt to exert an effect on high-value targets (such as ground-based aircraft, a specific command centre or maintenance areas) would require North Korea to conduct a relatively massive strike. Bases in the south of the peninsula, which are not particularly hardened and have no active defences, would, however, be much more vulnerable. For instance, until a few years ago the Gimhae Air Base, which is home to South Korea's tankers and E-7s, was not a conceivable target, but it could now be targeted by the KN-23.

<sup>160</sup> See Tang Junhui et al., 'Safety Analysis of THAAD Anti-Missile System Launcher,' *Journal of Physics* (Conference Series), 2021.



Figure 56. South Korea's KC-330 and E-7 on the tarmac at Gimhae



Source: Google Earth

Although South Korea has not yet acquired an IBCS architecture, and the interconnection of its missile defence (KDAM) equipment to the US IBCS will probably prove to be far from a simple matter, merging the sensor data should provide the network with very high-quality tracking data. Furthermore, while the adaptation of interceptors to quasi-ballistic threats (such as by modifying guidance algorithms and data links) probably remains to be carried out or completed, interception solutions should emerge, especially in an environment where defences are deployed *en masse*.<sup>161</sup> Finally, one of the principal

vulnerabilities of the PAC-3, linked to its relative mobility and the sectoral coverage of its radar, should be greatly reduced with the roll-out of a significantly more powerful version, which should be deployed around 2024–2025. The networking of US and South Korean assets and the development of a South Korean interceptor offering greater coverage than the current Cheolmae IIs (programme L-SAM, which could be deployed before 2030) would also make it possible to substantially reinforce the coverage of exposed sites, increasing the possibilities of interception.

### 5.3 The importance of defences in a coercive strike scenario

The analysis of different coercive strike operations highlights the crucial role played by defences. When designing a limited military action aiming to generate a major political effect, the planner expects a quick result, as it is generally impossible to carry out repeated strikes to guarantee the destruction of the target. The mere existence of active defences therefore complicates the offensive mission, since the probability of interception necessarily requires the use of multiple strike assets in order to guarantee the effect. In the case of South Korea, its overlapping, redundant layers of defences present the operational planner with a dilemma. If efforts are carried out to deliver a more massive strike, there is a risk that the nature of the military operation may be altered and that the adversary may perceive the strikes as initiating a major conflict. Conversely, an undersized strike may have a counterproductive political effect if the majority of the missiles are intercepted. The potential vulnerability of missile defence systems to quasi-ballistic missiles is also not inevitable: it can be mitigated by modernising and networking sensors and updating interceptor software, and also by deploying a layer of terminal interceptors specifically dedicated to engaging fast-maneuvring targets. In the balance of power between North Korea and the US and South Korea, missile defence technology is undergoing such rapid modernisation that the quasi-ballistic solution chosen by North Korea could prove to be a partial dead end, in the sense that the

<sup>161</sup> Moreover, within the framework of the IBCS, the coupling of smaller radars, which are currently optimised for the detection of aerial platforms and cruise missiles but could potentially be upgraded for the detection and tracking of faster objects, suggests a capability for fine tracking of quasi-ballistic missiles. In parallel, the development of architectures dedicated to the interception of hypersonic objects will necessarily contribute to improved capability for this type of threat.

considerable investment that has gone into it would ultimately not guarantee an acceptable penetration rate of the defences. However, the potential effectiveness of the future defences will continue to depend on the capability of the US and South Korea's forces to exert a constant strain on the North Korean launch systems, knowing that modernisation and innovation (such as the use of jammers on the missiles or against the radars, or the use of decoys, as seen in Ukraine on the SS-26) will necessarily limit the vulnerabilities of the next versions of the existing missiles.

Even assuming that missile defences have only a relatively low interception capability, their existence and rapid modernisation creates permanent uncertainty as to the impact of a limited strike. While a state with an effective arsenal facing a power with ageing defences can hope to gain a major political advantage from a strike by demonstrating the vulnerability of the adversary's system, this is not the case when defences are constantly being modernised (as is the case in South Korea), since the effects can only be guaranteed by saturating the defences. Consequently, North Korea would be taking a real risk by carrying out a limited strike, as even a partial failure would be likely to call into question the viability of its ballistic missile development programme, but above all to weaken the existing deterrent model. While the exposure of the regions bordering the DMZ obviously remains a point of vulnerability for South Korea, notably because the investment of C-RAM systems able to intercept heavy rockets remains to be made, its increasingly dense network of defences represents a significant security factor. As previously explained, securing a successful strike, even against vulnerable targets, may require the use of an increasing number of weapons, changing the nature of the conflict. The potential performance of the defences then mitigates the risk of blackmail from limited strikes. Moreover, as shown in the case of Israel with Iron Dome, high-performance defences also allow the nature of the response to be chosen and adapted precisely to the political imperatives of the moment. Consequently, under such circumstances, a military operation designed to secure a one-off political gain might ultimately place the North Korean regime in a position of lasting weakness.

It is noteworthy that this assessment of the role of missile defences in limited crisis management has been largely anticipated in recent years. Following this objective was a major part of the Obama administration's policy. A good summary of the methodology was presented by Brad Roberts in 2014,<sup>162</sup> with an emphasis on the utility of missile defences in situations of transition from crisis to open conflict.<sup>163</sup> Although the US approach has moved on, with the January 2019 *Missile Defense Review* (MDR)<sup>164</sup> strengthening the offensive dimension of the missile defence mission, a trend also observed on the South Korean side, the force postures of both countries are still built around a robust defensive capability that should provide Seoul and Washington with various options for managing escalation with North Korea.

As noted above, North Korea faces further challenging developments. The deployment of the IBCS architecture in the US army, the ongoing modernisation of PAC-3 systems and THAAD AN/TPY-2 radars, the probable development of new versions of the interceptor optimised for low-altitude interception and non-kinetic anti-missile devices (jamming and directed energy weapons), along with increased interoperability between the KDAM and US architectures and modernisation of the sensors of the US

---

<sup>162</sup> Brad Roberts served as Deputy Assistant Secretary of Defense for Nuclear and Missile Defense Policy between 2009 and 2013.

<sup>163</sup> Brad Roberts, *On the Strategic Value of Ballistic Missile Defense*, Institut Français des Relations Internationales, June 2014, <https://www.ifri.org/sites/default/files/atoms/files/pp50roberts.pdf>.

<sup>164</sup> Office of the Secretary of Defense, *2019 Missile Defense Review*, January 2019.

and South Korean navies are all factors likely to considerably erode North Korean deep strike capability.<sup>165</sup> Moreover, it is clear that the increase in South Korean and US strike capabilities represents a deterrent in all of the scenarios discussed above. This deterrent effect is, however, difficult to quantify. Both the Yeonpyeong bombardment and the Iranian attack on the Al Asad air base have shown that the strike power of a state or alliance alone cannot guarantee its safety from limited strikes. In the case of Yeonpyeong, it was also clear that the implementation of retaliation beyond the tactical level involved a cumbersome and possibly unsuccessful political and military process that Seoul seeks to address but that will inevitably remain highly complex. Nonetheless, the densification of defences, South Korea's ability to develop counter-strike and C4ISR systems and, possibly, to plan their use, and the increased interoperability of US and South Korean forces in both defensive and offensive terms will contribute to a drastic reduction of vulnerabilities

#### 5.4 Aspects to consider in a high-intensity conflict scenario

While the technical limitations of North Korea's current arsenal give the country a relatively constrained number of military options, the introduction of missiles capable of precision strikes may suggest that North Korea's strategies could evolve. The continual strengthening of US and South Korean defences and the shortage of C4ISR assets on the North Korean side limit the possibility of deep strikes by the North, but the military utility of the new weapons systems is clearly far greater than that of the Scud B and C and the KN-02.

However, any anticipation as to how a high-intensity conflict might play out remains very risky. If the idea of a complete strategic surprise is ruled out, in which South Korea is subjected to a massive attack without having detected the slightest hint of it – a highly implausible hypothesis – the activation of North Korean forces necessarily implies a dispersion of US and South Korean forces and an alerting of units remaining in the strike area. The weakness of North Korea's ISR assets would represent a deficiency that would be difficult to overcome from this point of view, as the inability to identify critical weapons systems present on site would substantially complicate attack planning. While the location of artillery units deployed to combat positions can be identified to some extent by counter-battery radar, defeating US and South Korean missile defence capability would be far more challenging, especially against targets deep into South Korean territory, where North Korea's small reconnaissance drones would not be able to operate.

At the same time, still supposing that all of the new missiles produced have a high defence penetration capability and maintain high accuracy, and that there is a sufficient stockpile of weapons with which to carry out conventional strike operations, the density of the US and South Korean facilities makes an effective ability to neutralise the Alliance's air power very unlikely. Although saturation strikes by the KN-09 and KN-25 from firing zones located about 60 km from the DMZ are feasible against most of the

---

<sup>165</sup> Conversely, countering Pyongyang's saturation strike capability at short ranges (50–150km) could prove far more challenging, as existing artillery interceptor systems (C-RAM) are far from proven against this type of threat. While the Israeli Iron Dome system has amply demonstrated that the C-RAM mission is feasible, this type of architecture is not suited to intercepting accurate and relatively fast salvo fire. The alternative solutions currently under development, notably within the framework of the American IFPC programme, do not allow for any evolution of interception capabilities in the short term. The possibilities of counter-strike at very short notice remain limited in the face of weapons systems capable of operating deep in North Korean territory. At present it seems difficult to envisage a solution to this problem.

major South Korean and US infrastructure as far out as the Pyeongtaek area, generating numerous vulnerabilities and possibly forcing Seoul and Washington to redeploy part of their air forces much further south, a significant portion of the North's saturation strike systems would necessarily be allocated to battlefield operations and artillery neutralisation, as North Korean forces would need to be able to block any military manoeuvre toward North Korea. There is therefore a significant difference between North Korea's theoretical strike capability, which could reach a number of air bases and alter the tempo of aircraft sorties, and its actual capability, which would probably be distributed across a large number of priority targets, particularly on the battlefield and in its immediate vicinity.

It would nonetheless be excessive to claim that the new systems do not generate vulnerabilities. At the tactical level, the KN-09 and KN-25 probably represent the beginning of a wholesale modernisation of North Korean artillery, which is now capable of operating from deep in its own territory and covering considerable portions of enemy territory. This modernisation is accompanied by the increasing development of tactical ISR drones, which will only become more marked in future. Pyongyang has indicated as much by displaying equipment at military parades, and has carried out several tactical infiltration operations. North Korea's first exercises combining ISR drones and artillery were late in coming (2010), but illustrate a gradual movement toward modern targeting capabilities. This modernisation and, ultimately, the organisation of a true C4ISR capability is difficult to assess from open sources, and it is impossible to determine the capacity of North Korean tactical drones to collect targeting information and transmit it in real time, or the capacity of the North's C4 to define a strike plan in a sufficiently short time to exploit the data collected and distribute the necessary information to units. Access to architecture allowing a fluid interface between ISR, C4 and firing units was formerly reserved for modern military powers, but has now become widely available. As such, if the modernisation of North Korea's artillery strike assets is accompanied by a modernisation of ISR architectures and systems, and if all of these assets are sufficiently resilient to remain functional in the event of conflict, this would dramatically transform the performance of the country's artillery.

Such transformation could lead to an increased vulnerability of the overall South Korean and US force posture. The combination of a C4ISR capable of continuously conducting operations during a conflict and precise weapons systems capable of operating beyond the range of the opponent's counter-strike assets could make it possible to economise on offensive assets and allocate them to a greater number of targets at a greater depth. On the battlefield, it would considerably increase the risks faced by concentrated units and therefore limit the possibility of manoeuvre. Finally, it poses a constant threat to support infrastructure, hindering the concentration of air and ground units and support operations for engaged forces. It could therefore mean that US and South Korean units are forced to adopt long-lasting strategies based on attrition, with military manoeuvres only possible after an enduring campaign of strikes aimed at dislocating the enemy's system.

It is naturally impossible to define how long the US and South Korea counter-attacks would be delayed and what could be the strategic impact of their inability to eliminate quickly, through ground operations, the bulk of the artillery threatening Seoul and Incheon. Beyond the destructions caused by enduring military operations, pursuing the conventional operations may not substantially affect their outcomes. Pyongyang would indeed probably be compelled to escalate, at least through the use of chemical weapons.

However, the real evolution may be in the way North Korea would use its chemical forces, notably if it can selectively target the military forces and infrastructures of its opponents, further delaying their ability to counter-attack and, simultaneously, generating an immense fear in the population and a considerable

pressure on South Korean authorities. The very short time between limited chemical operations and a more massive use, which could then lead to nuclear operations, may be harnessed to negotiate a pause.

This kind of scenario, rather schematic and even questionable, nonetheless tends to point out that North Korea's ability to sustain operations on a longer time frame without resorting to massive and indiscriminate use of chemical weapons may offer political solutions, even in the context of a high-intensity conflict. Hence, from a situation where an all-out conflict was quite systematically tantamount to defeat or utter destruction, some options may appear, allowing Pyongyang to propose a political exit and a suspension of the military operations.

The potential existence of political solutions does not suggest that North Korea is more likely to opt for an all-out conflict, but it may give Pyongyang more confidence in its ability to manage a crisis and to escalate from provocations to limited military operations. Such growing assertiveness also results from the transformation of its strategic forces, its potential ability to target the US territory, and the development of a tactical nuclear capability.

Even though the US and South Korea's military and political strategies will certainly mitigate these evolutions, both in conventional and nuclear dimensions, North Korea's growing ability to sustain a conflict under the WMD threshold, as well as to carry limited chemical operations in the depth of the peninsula, are leading to vulnerabilities that will not be easily addressed.

## 6 Conclusion

---

The aim of this study was to focus on North Korea's short-range ballistic missile capabilities, based on the observation that most studies underestimate the importance of short-range missiles, and to look at two fundamental parameters: the accuracy of these missiles and their ability to penetrate enemy defences. Seen in this context, the proliferation of certain technologies, particularly in the areas of guidance and propulsion, is creating new risks for European interests.

Studying these capabilities is even more important given that international reactions over the past five years have mostly focused on long-range and sea-launched missile tests. There is a twofold risk: the risk of trivializing short-range tests, and the risk of a relative lack of interest in them due to the resumption of long-range tests. All such tests, in fact, regardless of range, constitute a violation of international law, contribute to weakening the non-proliferation regime and further alter the balance of military power in the peninsula. Indeed, this research highlights the importance of shifting threat perception and awareness of proliferation risk by fully considering North Korea's growing ability to implement a strategy based on graduated strikes, from the tactical to the strategic level, which gives the country a new capacity to manage military escalation while still benefiting from its nuclear deterrent.

This report is fully aligned with the two objectives set out by the European Council in summer 2021, namely 'raising public awareness about the risks and threats posed by ballistic missile proliferation' and 'explor[ing], in particular through academic studies, possibilities of enhancing the [Hague] Code [of Conduct]'.<sup>166</sup> More broadly, it is consistent with the need for the European Union (EU) to develop autonomous analytical capabilities and expertise in the area of non-proliferation and beyond which is essential to guarantee European sovereignty. The development of short-range ballistic missile capabilities, in North Korea as well as elsewhere, also shows the importance of taking these weapons fully into account in promoting the Hague Code of Conduct (HCoC). This is particularly the case given the increase in the use of such weapons, from the Iranian strikes on the US Al Asad airbase in January 2020 to Russia's many strikes against military and civilian targets in Ukraine since February 2022.

Given all of the above, it is essential to develop a new grid of analytical frameworks in five specific areas, which can be summarised by the following dichotomies: long-range and short-range, quantitative and qualitative analysis, military and political dimensions, direct and indirect impact, and tangible and intangible technology transfer. Based on this observation, we also offer a number of specific proposals that can be summarised in five recommendations: strengthening European declaratory diplomacy in response to North Korean ballistic missile tests; raising the issue of North Korean ballistic missile proliferation in international forums; promoting European expertise in ballistic missile non-proliferation; providing greater support to United Nations (UN) Groups of Experts, including the panel on North Korea; and deepening the strategic partnership with South Korea.

---

<sup>166</sup> Annual Progress Report on the implementation of the European Union Strategy against the Proliferation of Weapons of Mass Destruction (2021), Official Journal of the European Union, C310/1, 2022/C, 16 August 2022.

## 6.1 North Korea's short-range capabilities transform the balance of power on the peninsula

As a result of the growing asymmetry between North Korea's conventional forces and the South Korean and US forces, North Korea has built its national defence strategy around weapons of mass destruction. The predominant idea remains that the purpose of these capabilities is to legitimise and protect the regime, with the logic of deterrence taking precedence over that of coercion. However, the modernisation of the country's ballistic arsenal and the revision of its military doctrine, including nuclear doctrine as of September 2022, increasingly seem to partially invalidate this hypothesis, as North Korea could now implement a coercive strategy based on its newly developed military capability.

As of 1 January 2023, North Korea has carried out over fifty tests of its three new single-stage, solid-propellant short-range ballistic missiles (KN-23, KN-24 and KN-25). These short-range ballistic systems have not received the same media or political attention as the country's long-range nuclear and ballistic missile capabilities. Yet North Korea's in-depth modernisation of its strategic arsenal facilitates a shift in the mission of its non-strategic arsenal, particularly in the Korean theatre, and enables Pyongyang to envisage more complex deterrent models based around conventional systems and chemical weapons, backed up by nuclear deterrence. The development of the short-range arsenal therefore represents a real capability shift that widens the military option of North Korea, notably in the framework of a limited military crisis. For example, a strategy based on graduated conventional strikes on the theatre, rhetorically linked with the potential use of weapons of mass destruction, would give the country non-negligible crisis management tools.

Assuming that the defences currently deployed in South Korea would be unable to intercept North Korea's quasi-ballistic systems, the increased accuracy of its missiles substantially improves North Korea's option to engage exclusively military targets with conventional weapons, adding a certain flexibility in managing escalation. Furthermore, Pyongyang already seems to have sufficiently precise strike capabilities to carry out selective operations against economic or military installations with a high symbolic impact or high industrial added value. This deterrence based on the ability to hold at risk major economic assets is nearly unique, as only very few other major industrial powers are exposed to conventional strike systems capable of having a lasting effect on entire sectors of the economy, in key sectors for global value chains.

While the doctrines governing the use of these short-range strike capabilities remain unclear, numerous tactical options are available. North Korea will eventually boast a coherent strike architecture organised in such a way as to facilitate the engagement of the force elements that pose the greatest threat to its own posture, namely missile defence systems, artillery deployments, and logistics concentrations. Moreover, it should not be forgotten that the development of conventional strike systems does not preclude the use of weapons of mass destruction. As the regime made explicitly clear in its new nuclear doctrine adopted in September 2022, its nuclear capability is being considered by the regime at both the strategic and tactical levels, and even though the main mission of the nuclear forces of the DPRK is to deter a war, their secondary mission is to carry out an 'operational mission' for achieving decisive victory of war in case its deterrence fails.

## 6.2 The need to strengthen frameworks for analysing ballistic missile risk and proliferation

This original study highlights a common bias in European, and more broadly Western, analyses of North Korean ballistic missile proliferation and capabilities. Besides its analytical and technical contribution, the report highlights the need to strengthen our analytical frameworks in five areas that can be summarised by the following dichotomies.

### 6.2.1 Long-range and short-range

From the first developments in North Korea's long-range strike capabilities in the 1990s (with the first test firing of Taepodong-1 in 1998), most analyses have focused on this type of long-range delivery vehicle. While this is an understandable preoccupation from the American perspective, since the United States is faced with the issue of extended deterrence and has no choice but to consider threats that may directly affect its territory, the bias is less understandable in the context of European analyses. Focusing political reaction and technical analysis almost exclusively on long-range systems is risky, as North Korea's growing confidence in military capacity and the multiplication of its provocations result as much in its capacity to strike the United States and, supposedly, to inhibit nuclear reprisal in case of major conflict, as in its emerging ability to inflict significant damages to the US and South Korean troops and infrastructures with its new short-range arsenal. Underestimating the role of short-range systems in the growing expansion of North Korea's military options on peninsula, opening the way for aggressive strategies of coercion, lead to the neglect of a determinant parameter of instability.

### 6.2.2 Quantitative and qualitative analysis

In addition to this, the analysis of North Korea's capabilities has long focused on the number of weapons available, regardless of their accuracy or defence penetration capability. North Korea still has a significant stockpile of several hundred of its previous generation of short-range ballistic missiles, derived from Soviet Scuds, but these are of limited operational use owing to their low accuracy and lack of effectiveness against military targets even when combined with chemical agents. In contrast, the new generation of missiles that has been developed, although currently few in number, is already having a significant impact by exposing potential vulnerabilities in the South Korean and US force postures. The (potential) accuracy of the missiles also has an effect on the type of munitions with which they can be combined effectively: conventional, nuclear, bacteriological, or chemical. Technical analysis of both the weapons and their payloads is therefore important and allows for a better understanding of the potential relationship between exclusively conventional uses and combined uses of conventional ammunition and weapons of mass destruction. Such analysis is substantially complicated, however, by the extreme lack of information on the technical characteristics of North Korean missiles.

### 6.2.3 Military and political dimensions

It is also crucial to consider the military and political impact that the development of these short-range ballistic missiles is likely to have. Weapons of mass destruction generate a political effect by virtue of their mere existence, and in proportion to the likelihood of their use. Since these factors are linked to



the ability to control the effects of the weapons, the power of the delivery system, and its precision and penetration capability, these are all elements that can make use more credible. The political effect of North Korean deterrents will inevitably be enhanced if the likelihood of Pyongyang using its arsenal in a limited and controlled way is increased by the quality of its military equipment. This transformation of the deterrent has obvious political effects as far as crisis management is concerned, not only influencing the capacity of the South Korean or US governments to react, but also exerting greater pressure upon public opinion. While the South Korean population is already largely in favour of the nuclearisation of their country, even in the face of potential international sanctions, public pressure will continue to build in response to the growing perception of an increasingly concrete North Korean military threat.<sup>167</sup> Moreover, from the North Korean perspective, the development of these capabilities helps strengthen the techno-nationalism promoted by the regime by emphasizing its technological and scientific achievements, and thus its legitimacy. In particular, the sciences linked to national defence serve to distinguish present-day North Korea from its historical status as a formerly colonised and militarily inferior state. This political, identity-related, dimension further mitigates any likelihood of these military capabilities being consensually dismantled.

#### **6.2.4 Direct and indirect impact**

The exposure of a major industrial power such as South Korea to a ballistic missile strike raises issues that must be addressed by the international community. South Korea's status as a major industrial power, particularly in the production of ultra-high-tech goods and services, including semiconductor manufacturing, generates vulnerabilities that go beyond the country to impact upon all global value chains. If Pyongyang were to attempt to apply a coercive policy by striking sensitive industrial infrastructure targets, the impact would be felt far beyond the peninsula. Clearly, this strike capability is very closely linked to the short-range missiles available, and is partially independent of strategic weaponry, since the destruction of one or more factories by conventional precision strikes remains an act of war that is limited in scope, especially if it does not result in civilian casualties. Yet, to be clear, the decoupling function of the strategic arsenal contributes directly to the military function of the non-strategic arsenal and both aspects of the threat should be addressed as a whole and not selectively. The development of North Korean short-range strike systems may also have significant economic impacts by their very existence, by reducing investor confidence in the long-term resilience of the South Korean economy, even in the absence of conflict.

#### **6.2.5 Tangible and intangible technology transfer**

North Korea remains a potential source of ballistic proliferation and the export of ballistic missiles such as the KN-23 or the transfer of some of its technologies are a considerable threat. The proliferation of such weapons systems to Africa or the Middle East would pose an increased risk to European forces deployed in these regions and could increase regional instability. In addition, North Korea's rapidly acquired expertise in quasi-ballistic technologies and solid-propellant systems raises numerous questions about the direction and transformation of missile proliferation. Although this study has shown

---

<sup>167</sup> Toby Dalton, Karl Friedhoff and Lami Kim, *Thinking Nuclear: South Korean Attitudes on Nuclear Weapons*, Chicago Council on Global Affairs, February 2022.

that the acquisition of these capabilities is likely to have taken at least twenty years, the possibility of traditional modes of proliferation having also helped North Korea acquire expertise in these technologies should not be ruled out, such as the direct transfer of technology, components, or complete systems. But most importantly, North Korea's ability to conduct mostly successful flight tests suggests the role played by modelling, software tools, intangible transfers, and possibly additive manufacturing in the current proliferation environment. As such, many loopholes continue to exist in the various national dual-use export control regulations that do not necessarily cover transfers of knowledge or technical assistance in-country.

## 6.2.6 A credible European commitment to ballistic missile non-proliferation

Non-proliferation is a priority widely supported in the EU and among its Member States, and is a key objective of the EU's global strategy. It is also an area in which the EU has internationally recognised expertise. The North Korean nuclear and ballistic missile crisis is the most serious proliferation crisis currently facing the EU and its Member States on the world stage. Yet it is sometimes difficult to mobilise all EU members, as some do not consider the North Korean crisis to affect their immediate surroundings.

There are numerous initiatives in place at the EU and EU Member State levels, but a more coordinated approach is needed in order to deal with the North Korean proliferation crisis, and additional initiatives are required. As one of the co-authors of a 2020 study for the EU Non-Proliferation and Disarmament Consortium suggested, the EU might consider shifting its strategy toward North Korea from one of critical engagement to a more proactive strategy of credible commitments, particularly in the area of ballistic missile non-proliferation. Such a strategy could involve, among other things:

- ❖ *Strengthening European declaratory diplomacy in response to ballistic missile tests.* The lack of clear condemnation of certain North Korean violations of UN Security Council resolutions, specifically short-range ballistic missile tests, erodes the non-proliferation regime, weakens the commitment of the EU and its Member States to defending this regime, and undermines the credibility of international institutions. There should be a robust political response to each and every test, including short-range tests. In addition, the EU Strategy for Cooperation in the Indo-Pacific, as presented in September 2021, should address even more explicitly the risk of ballistic missile proliferation in the region and the specific case of North Korea, which is not currently mentioned in the document.
- ❖ *Raising the issue of North Korean ballistic missile proliferation in international forums.* The European External Action Service (EEAS), in close coordination with EU Member States, has a responsibility to take up this issue and raise it in all international forums, including the UN General Assembly, the Conference on Disarmament, the HCoC, and the NPT Preparatory Committees and Review Conferences. The EEAS should also continue to promote the HCoC as the only multilateral instrument for transparency and confidence-building in relation to missile proliferation.
- ❖ *Promoting European expertise in ballistic missile non-proliferation.* Supporting studies of the capabilities and doctrines of proliferating states would raise awareness among policy makers in Member States and provide the EU with additional conceptual tools to promote its policies. Initial steps have already been taken in this direction by funding a database of missiles, tests,

and production sites. Promoting this database and transforming it into an operational tool for the benefit of the academic community is an easily achievable short-term objective. For example, one might envisage an annual EU publication drawing on this database, listing ballistic missile tests and space launches carried out that year. These studies should also be promoted by being presented by European researchers as part of international conference cycles such as the IISS Missile Dialogue Initiative, the 3AF Integrated Air and Missile Defence Conference, the RUSI Missile Defence Conference, side events at HCoC annual meetings, and of course the annual conference of the EU Non-Proliferation Consortium. In addition, the EU Non-Proliferation and Disarmament Consortium (EUNPDC), established in 2010 and extended by Council Decision 2018/299/CFSP, should create an expert working group on North Korea's nuclear and ballistic missile proliferation challenge in order to strengthen independent European expertise.

- ❖ *Providing greater support to UN Groups of Experts.* The EU could use these ballistic missile non-proliferation studies to support the work and reflections of the Groups of Experts, in particular the one established pursuant to UN Security Council Resolution 1874 of 12 June 2009. These various studies could be presented during the experts' visits to Brussels, which could be made more frequent or even scheduled on a regular basis. The appointment of a ninth expert representing the EU, in addition to the expert from France, would also indicate that the EU is fully committed to supporting the panel.
- ❖ *Deepening the strategic partnership with South Korea.* More detailed knowledge of security and defence issues on the peninsula will help reinforce the credibility of the EU as a cooperation partner of South Korea. The specific characteristics of North Korean proliferation, which is still largely based on Soviet- and Russian-derived technologies, also afford some European experts some legitimacy in addressing ballistic missile proliferation issues, including long-range missiles. Finally, such research should make it possible to foster cooperation with South Korean research centres, in particular the Korea Institute for Defense Analyses (KIDA) and the Institute for National Security Strategy (INSS). □

## THE HAGUE CODE OF CONDUCT

# HCoC

The objective of the HCoC is to prevent and curb the proliferation of ballistic missiles systems capable of delivering weapons of mass destruction and related technologies. Although non-binding, the Code is the only universal instrument addressing this issue today. Multilateral instrument of political nature, it proposes a set of transparency and confidence-building measures. Subscribing States are committed not to proliferate ballistic missiles and to exercise the maximum degree of restraint possible regarding the development, the testing and the deployment of these systems.

*The Hague Code of Conduct*

The Fondation pour la Recherche Stratégique, with the support of the Council of the European Union, has been implementing activities which aim at promoting the implementation of the Code, contributing to its universal subscription, and offering a platform for conducting discussions on how to further enhance multilateral efforts against missile proliferation.

## CONTACTS



### Service européen pour l'action extérieure (SEAE)

EEAS Building, Rond-Point Schuman 9A  
1040 Bruxelles, Belgique



### Fondation pour la Recherche Stratégique

55 rue Raspail

## USEFUL LINKS

[www.hcoc.at](http://www.hcoc.at)

[www.nonproliferation.eu/hcoc](http://www.nonproliferation.eu/hcoc)



This project is financed by the European Union



This project is implemented by the Fondation pour la Recherche Stratégique